



KAY PARK RECREATION

MAKING PLACES PEOPLE FRIENDLY • **SINCE 1954**

2020
Catalog



Tables, Benches, Litter Receptacles, Grills, Bike Racks, Highway Towable Bleachers & Stages and so MUCH MORE!

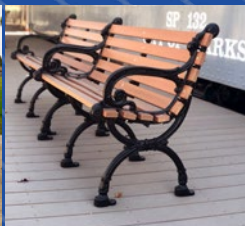
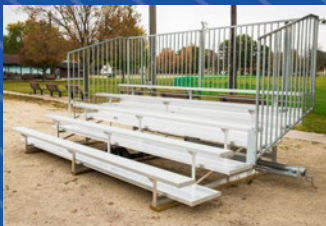

Kay Park Recreation

Table of Contents

Ash/Trash Rec.:

Hot Ash	24
Litter Recept.	28-31
Snuffers	32, 58
Concrete Trash	36
Windsor Select	47
Recycled Plastic	28, 43,49
Thermoplastic	57
Strap Steel	58
Iron Valley	59

Bag Toss:

	34
--	----

Benches:

Concrete	38
Courtyard	42-43
Park Benches	45-46, 48-50, 53, 66-71
Aluminum Cast	45
Windsor Select	46
Thermoplastic	56
Strap Steel Amenities	58
Iron Valley Amenities	59
Portable Benches	66-68
Stationary Benches	69-71
Player Benches	66-72

Bike Storage & Racks:

	61-65
--	-------

Bleachers:

	74-89
--	-------

Bollards:

	35
--	----

Car Stops

	52
--	----

Concrete Site Amenities:

	34-39
--	-------

Canoes:

	92-93
--	-------

Crowd Control:

	72
--	----

Dog Park Equipment

	26, 27, 40, 41, 56, 57
--	------------------------

Drinking Fountains:

	39-41
--	-------

Flag & Flag Poles:

	33
--	----

Grills & Fire Rings:

	21-25
--	-------

Iron Valley:

	59
--	----

Ladder Toss:

	34
--	----

Message Centers:

	52
--	----

NuCanoe

	92-93
--	-------

Pedal Boats:

	90-91
--	-------

Perforated Steel:

	56-57
--	-------

Pet Waste Stations:

	26
--	----

Park Pong:

	34
--	----

Planters:

Concrete	39
----------	----

Windsor	46
---------	----

Strap Steel	58
-------------	----

Plaques:

	44
--	----

Shades (Bleacher/Dugout):

	73
--	----

Snuffers:

	32, 58
--	--------

Solar Charge Station

	60
--	----

Strap Steel Amenities:

	58-59
--	-------

Tables:

Rectangular	4-14, 17, 37, 47, 49, 51, 55, 57
-------------	----------------------------------

Round	14-17, 37, 51,53, 55, 57, 60
-------	------------------------------

Square	14, 16,-17, 37, 47, 55, 57
--------	----------------------------

Pedestal	14, 47
----------	--------

Concrete	37
----------	----

Windsor Select	47
----------------	----

Recycled Plastic	4-14, 16-17, 47, 49, 51, 53
------------------	-----------------------------

Perforated Steel	55, 57
------------------	--------

Umbrellas:

	18-20, 60
--	-----------

Windsor Select Site Amenities:

	46-47
--	-------

Our Guarantee:

Kay Park guarantees all materials and workmanship (except labor and transportation) for one year, excluding vandalism, misuse, and acts of God. Claim for defects must be filed within one year, accompanied by copy of original invoice or invoice number.

Quick Ship Symbol

Look for this symbol to indicate Quick Ship items. Quick Ship items will ship in 7 business days from receipt of order. For quantities above 4 call for lead-time.

2 Day Shipping



Look for this symbol to indicate 2 day shipping items. For quantities up to approximately 4 only. Inquire for larger quantities.

Kay Park Recreation

Kay Park Recreation has been a manufacturer of commercial outdoor furniture since 1954. We offer a large selection of park and playground equipment and commercial grade site furnishings, including outdoor tables, grills, benches, trash containers, drinking fountains, planters, umbrellas, bollards, shade canopies and bike racks. We have a complete line of bleachers and grandstands, as well as some outdoor athletic equipment, ADA products and a rental heavy-duty fiberglass pedal boat.

Please browse through our selection and feel free to contact us if you have any questions.

1-800-553-2476, sales@kaypark.com, www.kaypark.com

Our Manufacturing Facility



Our Mission Statement:

We do this to help you build and fulfill your vision of people friendly environments. One that invites people to stay, enjoy your space with new acquaintances, friends and family. Every place has different needs and we are here to help bring your needs to life. We see cities, parks, ball fields and your people spaces across America busy with people who are staying as long they wish because the amenities are comfortable, functional and inviting.

Every design choice, every material choice and product choice is challenged by the question “Is this people friendly?”. For decades, starting with our founder Keith Borglum, a good enough design has never been good enough. Our products are built to last so that the next time you are buying products, it is because you want new designs.



J2 Series Welded Frame Tables - 2 3/8" O.D. Pipe, Galvanized After Fabrication



Shown: J2C-6 Frame Only

Frame Only Plus Hardware:

J2G-6	Galvanized Frame for 6'	108 Lbs	\$238.00
J2G-8	Galvanized Frame for 8'	108 Lbs	\$238.00
J2G-12	Galvanized Frame for 12'	146 Lbs	\$386.00
J2C-6	Coated Frame for 6'	108 Lbs	\$238.00
J2C-8	Coated Frame for 8'	108 Lbs	\$238.00
J2C-12	Coated Frame for 12'	146 Lbs	\$386.00



* Quick Ship Galvanized Frame ONLY*



Shown: 6J2CF Fiberglass

Fiberglass Plank Table

6J2GF	6' Galvanized Frame	223 Lbs	\$ 925.00
8J2GF	8' Galvanized Frame	269 Lbs	\$ 1,107.00
6J2CF	6' Coated Frame	223 Lbs	\$ 925.00
8J2CF	8' Coated Frame	269 Lbs	\$ 1,107.00

Fiberglass:

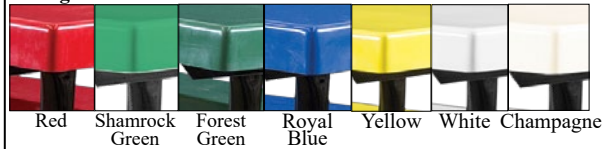

WARNING: Cancer and Reproductive Harm www.P65Warnings.com



Shown: 6J2CRRP Recycled Plastic

Recycled Plastic Plank Table

6J2GRRP	6' Galvanized Frame	261 Lbs	\$ 810.00
8J2GRRP	8' Galvanized Frame	333 Lbs	\$ 970.00
6J2CRRP	6' Coated Frame	261 Lbs	\$ 810.00
8J2CRRP	8' Coated Frame	333 Lbs	\$ 970.00



Recycled Plastic:



- 2 3/8" O.D. pipe
- Hot dip galvanized after fabrication or powder coated black.
- Center cleat holds top level.
- 1 5/16" O.D. Cross braces stabilize this extra heavy frame.
- Convenient walk-thru design and welded rigidity can stand up to rough use.
- This frame can be purchased as a frame set only, including hardware, or with your choice of planking to make a complete table.

*American Made
Quality You Can Trust*



Anchors

UGANCH	Under ground table anchor	1 Lbs	\$ 24.00
CANCH2G	Galvanized table clamp	1 Lbs	\$ 20.00
CANCH2C	Coated table clamp	1 Lbs	\$ 20.00



J2 Series Welded Frame Tables



Shown: 6J2GVP Vinyl Plastisol



6' & 8' Green & Black Vinyl Plastisol Only

Quality Thick Vinyl Plastisol:

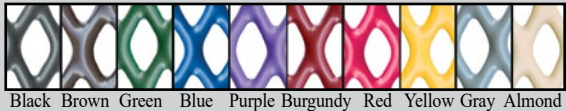

Than Thermoplastic

6J2GVP	6' Galvanized Frame	265 Lbs	\$ 917.00
8J2GVP	8' Galvanized Frame	333 Lbs	\$ 1,134.00
6J2CVP	6' Coated Frame	265 Lbs	\$ 917.00
8J2CVP	8' Coated Frame	333 Lbs	\$ 1,134.00

WARNING: Cancer and Reproductive Harm www.P65Warnings.com



Shown: 6J2GW Wood

Treated Southern Yellow Pine Wood Plank Table

6J2GW	6' Galvanized Frame	215 Lbs	\$ 369.00
8J2GW	8' Galvanized Frame	255 Lbs	\$ 405.00
12J2GW	12' Galvanized Frame	386 Lbs	\$ 693.00
6J2CW	6' Coated Frame	215 Lbs	\$ 369.00
8J2CW	8' Coated Frame	225 Lbs	\$ 405.00
12J2CW	12' Coated Frame	386 Lbs	\$ 693.00



* Quick Ship Galvanized Frame ONLY*



Aluminum Plank Table

6J2GA	6' Galvanized Frame	147 Lbs	\$ 656.00
8J2GA	8' Galvanized Frame	165 Lbs	\$ 737.00
12J2GA	12' Galvanized Frame	249 Lbs	\$ 1,088.00
6J2CA	6' Coated Frame	147 Lbs	\$ 656.00
8J2CA	8' Coated Frame	165 Lbs	\$ 737.00
12J2CA	12' Coated Frame	249 Lbs	\$ 1,088.00



* Quick Ship Galvanized Frame ONLY*

CJ Series Welded Frame Tables - 1 5/8" O.D. Pipe, Galvanized After Fabrication



Shown: CJC-6
Frame Only

Frame Only Plus Hardware:

CJG-6	Galvanized Frame for 6'	79 Lbs	\$190.00
CJG-8	Galvanized Frame for 8'	79 Lbs	\$190.00
CJG-12	Galvanized Frame for 12'	122 Lbs	\$319.00
CJC-6	Coated Frame for 6'	79 Lbs	\$190.00
CJC-8	Coated Frame for 8'	79 Lbs	\$190.00
CJC-12	Coated Frame for 12'	122 Lbs	\$319.00



* Quick Ship Galvanized Frame ONLY*



Shown: 6CJCF Fiberglass

Fiberglass Plank Table

6CJGF	6' Galvanized Frame	207 Lbs	\$ 886.00
8CJGF	8' Galvanized Frame	245 Lbs	\$ 1,066.00
6CJCF	6' Coated Frame	207 Lbs	\$ 886.00
8CJCF	8' Coated Frame	245 Lbs	\$ 1,066.00

Fiberglass:

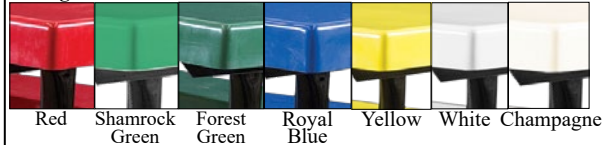

WARNING: Cancer and Reproductive Harm www.P65Warnings.com



Shown: 6CJCRRP
Recycled Plastic

Recycled Plastic Plank Table

6CJGRRP	6' Galvanized Frame	258 Lbs	\$ 742.00
8CJGRRP	8' Galvanized Frame	298 Lbs	\$ 889.00
6CJCRRP	6' Coated Frame	258 Lbs	\$ 742.00
8CJCRRP	8' Coated Frame	298 Lbs	\$ 889.00



Recycled Plastic:



- 1 5/8" O.D. pipe
- Hot dip galvanized after fabrication or powder coated black.
- Center cleat holds top level
- 2" x 2" x 3/16" steel angles
- 1 5/16" OD Cross braces, stabilize the table
- Convenient walk-thru design and welded rigidity can stand up to rough use.
- This frame can be purchased as a frame set only, including hardware, or with your choice of planking to make a complete table.

Great Value!



Anchors

UGANCH	Under ground table anchor	1 Lbs	\$ 24.00
CANCH2G	Galvanized table clamp	1 Lbs	\$ 20.00
CANCH2C	Coated table clamp	1 Lbs	\$ 20.00



Shown: 6CJGW Wood

Treated Southern Yellow Pine Wood Plank Table

6CJGW	6' Galvanized Frame	199 Lbs	\$ 315.00
8CJGW	8' Galvanized Frame	241 Lbs	\$ 352.00
12CJGW	12' Galvanized Frame	362 Lbs	\$ 614.00
6CJCW	6' Coated Frame	199 Lbs	\$ 315.00
8CJCW	8' Coated Frame	241 Lbs	\$ 352.00
12CJCW	12' Coated Frame	362 Lbs	\$ 614.00



* Quick Ship Galvanized Frame ONLY*



Shown: 6CJCVP
Vinyl Plastisol

Plastisol Plank (PVC) Table

6CJGVP	6' Galvanized Frame	243 Lbs	\$ 879.00
8CJGVP	8' Galvanized Frame	306 Lbs	\$ 1,097.00
6CJCVP	6' Coated Frame	243 Lbs	\$ 879.00
8CJCVP	8' Coated Frame	306 Lbs	\$ 1,097.00

Quality Thick Vinyl Plastisol:

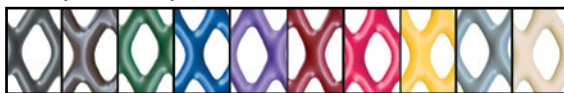

Black Brown Green Blue Purple Burgundy Red Yellow Gray Almond



WARNING: Cancer and Reproductive Harm www.P65Warnings.com



Aluminum Plank Table

6CJGA	6' Galvanized Frame	132 Lbs	\$ 581.00
8CJGA	8' Galvanized Frame	151 Lbs	\$ 667.00
12CJGA	12' Galvanized Frame	229 Lbs	\$ 1,017.00
6CJCA	6' Coated Frame	132 Lbs	\$ 581.00
8CJCA	8' Coated Frame	151 Lbs	\$ 667.00
12CJCA	12' Coated Frame	229 Lbs	\$ 1,017.00



* Quick Ship Galvanized Frame ONLY*

2BG Series Bolted Frame Tables-2 3/8" O.D. Galvanized Tube



Shown:682BG Frame Only

Frame Only Plus Hardware:

682BG	Galvanized Frame for 6' or 8'	84 Lbs	\$ 200.00
682BC	Coated Frame for 6' or 8'	84 Lbs	\$ 257.00



* Quick Ship Galvanized Frame ONLY*



Shown: 62BGF Blue Fiberglass

Fiberglass Plank Table

62BGF	6' Galvanized Frame	208 Lbs	\$ 789.00
82BGF	8' Galvanized Frame	244 Lbs	\$ 1,016.00
62BCF	6' Coated Frame	208 Lbs	\$ 847.00
82BCF	8' Coated Frame	244 Lbs	\$ 1,075.00

Fiberglass:

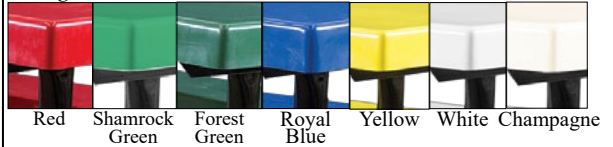

Shown: 62BGRRP Gray Recycled Plastic

Recycled Plastic Plank Table

62BGRRP	6' Galvanized Frame	257 Lbs	\$ 770.00
82BGRRP	8' Galvanized Frame	297 Lbs	\$ 924.00
62BCRRP	6' Coated Frame	257 Lbs	\$ 828.00
82BCRRP	8' Coated Frame	297 Lbs	\$ 970.00



Recycled Plastic:



WARNING: Cancer and Reproductive Harm www.P65Warnings.com

- 2 3/8" O.D. Pre galvanized tube with a shiny clear coat standard.
- 1 5/16" Cross braces stabilize this extra heavy frame.
- 10 ga. steel seat brackets
- 2" x 2" steel top angles
- Powder coated black, optional at extra cost.
- This frame can be purchased as a frame set only, including hardware, or with your choice of planking to make a complete table.

Extra heavy - duty!



Anchors

UGANCH	Under ground table anchor	1 Lbs	\$ 24.00
CANCHIG	Galvanized table clamp	1 Lbs	\$ 20.00
CANCHIC	Coated table clamp	1 Lbs	\$ 20.00

2BG Series Bolted Frame Tables



Shown: 62BGA
Aluminum

Aluminum Plank Table

62BGA	6' Galvanized Frame	133 Lbs	\$ 584.00
82BGA	8' Galvanized Frame	151 Lbs	\$ 668.00
62BCA	6' Coated Frame	133 Lbs	\$ 645.00
82BCA	8' Coated Frame	151 Lbs	\$ 728.00



* Quick Ship Galvanized Frame ONLY*



Shown: 62BGVP Red Seats Black Top Vinyl Plastisol Plank

Plastisol Plank (PVC) Table

62BGVP	6' Galvanized Frame	244 Lbs	\$ 890.00
82BGVP	8' Galvanized Frame	305 Lbs	\$ 1,099.00
62BCVP	6' Coated Frame	244 Lbs	\$ 946.00
82BCVP	8' Coated Frame	305 Lbs	\$ 1,143.00

Quality Thick Vinyl Plastisol:

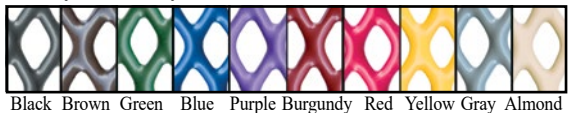

Black Brown Green Blue Purple Burgundy Red Yellow Gray Almond

WARNING: Cancer and Reproductive Harm www.P65Warnings.com



Shown: 62BGW SYP Wood

Treated Southern Yellow Pine Wood Plank Table

62BGW	6' Galvanized Frame	198 Lbs	\$ 344.00
82BGW	8' Galvanized Frame	238 Lbs	\$ 376.00
62BCW	6' Coated Frame	198 Lbs	\$ 404.00
82BCW	8' Coated Frame	238 Lbs	\$ 437.00



* Quick Ship Galvanized Frame ONLY*

BG Series Bolted Frame Tables- 1 5/8" O.D. Galvanized Tube



Shown: 68BG

Frame Only Plus Hardware:

68BG	Galvanized Frame for 6' or 8'	79 Lbs	\$ 147.00
68BC	Coated Frame for 6' or 8'	79 Lbs	\$ 203.00



* Quick Ship Galvanized Frame ONLY*



Shown: 6BCF Yellow Fiberglass

Fiberglass Plank Table

6BGF	6' Galvanized Frame	183 Lbs	\$ 748.00
8BGF	8' Galvanized Frame	221 Lbs	\$ 985.00
6BCF	6' Coated Frame	183 Lbs	\$ 807.00
8BCF	8' Coated Frame	221 Lbs	\$ 1,044.00

Fiberglass:

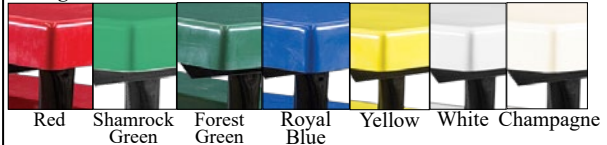

Shown: 6BGW Wood Plank

Treated Southern Yellow Pine Wood Plank Table

6BGW	6' Galvanized Frame	173 Lbs	\$ 278.00
8BGW	8' Galvanized Frame	212 Lbs	\$ 315.00
6BCW	6' Coated Frame	173 Lbs	\$ 338.00
8BCW	8' Coated Frame	212 Lbs	\$ 373.00



* Quick Ship Galvanized Frame ONLY*



WARNING: Cancer and Reproductive Harm www.P65Warnings.com

- 1 5/8" O.D. Pre galvanized tube with a shiny clear coat standard.
- 1 5/16" Cross braces stabilize this extra heavy frame.
- 2" x 2" Steel top angles
- Powder coated black, optional at extra cost.
- This frame can be purchased as a frame set only, including hardware, or with your choice of planking to make a complete table.

Anchors



UGANCH	Under ground table anchor	1 Lbs	\$ 24.00
CANCH1G	Galvanized table clamp	1 Lbs	\$ 20.00
CANCH1C	Coated table clamp	1 Lbs	\$ 20.00

*Commercial - duty
at
economical price!*



Shown: 6BGRRP Cedar Recycled Plastic Plank

Recycled Plastic



6BGRRP	6' Galvanized Frame	233 Lbs	\$ 702.00
8BGRRP	8' Galvanized Frame	275 Lbs	\$ 860.00
6BCRRP	6' Coated Frame	223 Lbs	\$ 758.00
8BCRRP	8' Coated Frame	275 Lbs	\$ 916.00



Shown: 6BGVP Yellow Seats Blue Top Vinyl Plastisol Plank

Plastisol Plank (PVC) Table

6BGVP	6' Galvanized Frame	219 Lbs	\$ 823.00
8BGVP	8' Galvanized Frame	281 Lbs	\$ 1,032.00
6BCVP	6' Coated Frame	219 Lbs	\$ 880.00
8BCVP	8' Coated Frame	281 Lbs	\$ 1,089.00

Quality Thick Vinyl Plastisol:

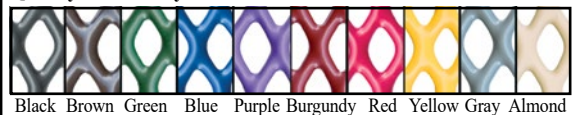

WARNING: Cancer and Reproductive Harm www.P65Warnings.com



Aluminum Plank Table

6BGA	6' Galvanized Frame	108 Lbs	\$ 515.00
8BGA	8' Galvanized Frame	126 Lbs	\$ 599.00
6BCA	6' Coated Frame	108 Lbs	\$ 576.00
8BCA	8' Coated Frame	126 Lbs	\$ 659.00



* Quick Ship Galvanized Frame ONLY*

J2GWC Welded Frame Tables - 2 3/8" O.D Pipe

New!



8J2CA-UWC
Aluminum



Universal Access Table - 2 Wheelchair Spaces

- 2 3/8" O.D. Pipe
- **ADA 24" Overhang 30" W and 29" H Clearance**
- Galvanized after fabrication or powder coated black
- Dual end ADA access
- *Standard frame galvanized 'G' change to 'C' for powder coat*

8J2G-UWC	8' Frame only	138 Lbs	\$ 302.00
8J2GW-UWC	8' Treated SYP Wood	282 Lbs	\$ 501.00
8J2GA-UWC	8' Aluminum	201 Lbs	\$ 795.00
8J2GF-UWC	8' Fiberglass	269 Lbs	\$ 1,014.00
8J2GVP-UWC	8' Vinyl Plastisol (PVC)	342 Lbs	\$ 1,077.00
8J2GRRP-UWC	8' Recycled Plastic	340 Lbs	\$ 1,018.00

Add ADA
Without
Losing Seats!



8J2CVP-UWC
Plastisol

Best Seller

**Safe
Sturdy
Design**



End Access Table - 1 Wheelchair Space

- 2 3/8" O.D. Pipe
- **ADA 24" Overhang 30" W and 29" H Clearance**
- Galvanized after fabrication or powder coated black
- 6' Seats with 8' Top
- Patented anti-tip extensions
- *Standard frame galvanized 'G' change to 'C' for powder coat*



8J2CVP-EWC
Plastisol

← Anti-tip extensions.

8J2G-EWC	8' Frame only	106 Lbs	\$ 280.00
8J2GW-EWC	8' Treated SYP Wood	250 Lbs	\$ 434.00
8J2GA-EWC	8' Aluminum	169 Lbs	\$ 672.00
8J2GF-EWC	8' Fiberglass	237 Lbs	\$ 1,066.00
8J2GVP-EWC	8' Vinyl Plastisol (PVC)	310 Lbs	\$ 1,136.00
8J2GRRP-EWC	8' Recycled Plastic	308 Lbs	\$ 974.00



← Anti-tip extensions.

8J2CRRP-SEWC
Recycled Plastic

Patented Seat
Stabilizer
Bracket



Side + End Access Table - 2 Wheelchair Spaces

- 2 3/8" O.D. Pipe
- **ADA 24" Overhang 30" W and 29" H Clearance**
- Galvanized after fabrication or powder coated black
- Side Plus End Access
- Patented anti-tip extensions (pat#6116681)
- *Standard frame galvanized 'G' change to 'C' for powder coat*

8J2G-SEWC	8' Frame only	120 Lbs	\$ 366.00
8J2GW-SEWC	8' Treated SYP Wood	250 Lbs	\$ 467.00
8J2GA-SEWC	8' Aluminum	177 Lbs	\$ 682.00
8J2GF-SEWC	8' Fiberglass	255 Lbs	\$ 1,108.00
8J2GVP-SEWC	8' Vinyl Plastisol (PVC)	315 Lbs	\$ 1,139.00
8J2GRRP-SEWC	8' Recycled Plastic	300 Lbs	\$ 1,015.00

Plank Color Options For
Page 12 & 13

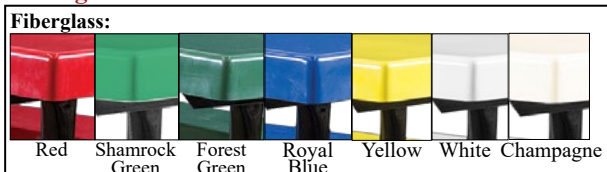

Fiberglass:

Red Shamrock Green Forest Green Royal Blue Yellow White Champagne



WARNING:
Cancer and
Reproductive Harm
www.P65Warnings.com

Fiberglass & Vinyl Plastisol

Recycled Plastic:



Brown Cedar Gray
Steel Reinforced

J2GWC Welded Frame Tables - 2 3/8" O.D Pipe



6J2GW-SWC
SYP Wood

Side Access Table - 1 Wheelchair Space



- 2 3/8" O.D. Pipe
- **ADA 24" Overhang 30" W and 29" H Clearance**
- Galvanized after fabrication or powder coated black
- Side Access
- Patented anti-tip extensions (pat#6116681)
- *Standard frame galvanized 'G' change to 'C' for powder coat*

*See Page 22 & 25 For
ADA Grills and Fire Rings!*

6J2G-SWC	6' Frame only	107 Lbs	\$ 300.00
6J2GW-SWC	6' Treated SYP Wood	213 Lbs	\$ 415.00
6J2GA-SWC	6' Aluminum	155 Lbs	\$ 580.00
6J2GF-SWC	6' Fiberglass	225 Lbs	\$ 842.00
6J2GVP-SWC	6' Vinyl Plastisol (PVC)	251 Lbs	\$ 941.00
6J2GRRP-SWC	6' Recycled Plastic	251 Lbs	\$ 822.00
8J2G-SWC	8' Frame only	107 Lbs	\$ 300.00
8J2GW-SWC	8' Treated SYP Wood	246 Lbs	\$ 438.00
8J2GA-SWC	8' Aluminum	167 Lbs	\$ 667.00
8J2GF-SWC	8' Fiberglass	252 Lbs	\$ 1,072.00
8J2GVP-SWC	8' Vinyl Plastisol (PVC)	311 Lbs	\$ 1,122.00
8J2GRRP-SWC	8' Recycled Plastic	305 Lbs	\$ 996.00

Round ADA Table - 1 Wheelchair Space



- 1 5/8" O.D. Pipe
- **ADA 24" Overhang 30" W and 29" H Clearance**
- Standard frame powder coated black 'C'

RTRCFADA	Frame w/ Fiberglass top & seats	153 Lbs	\$ 818.00
RTRCVPADA	Frame w/ Plastisol top & Seats	336 Lbs	\$ 1,037.00
RTRCFVPSADA	Frame w/ Fiberglass top & Plastisol Seats	376 Lbs	\$ 994.00



RTRCFADA
Fiberglass

Plastisol:



*Thicker, Softer Protection
For Long-Lasting
Durability.*

Quality Thick Vinyl Plastisol:

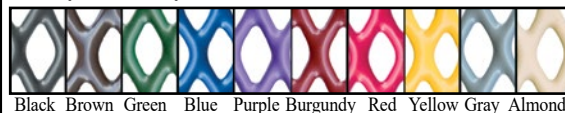

WARNING:
Cancer and
Reproductive Harm
www.P65Warnings.com
Fiberglass & Vinyl Plastisol

2020

Pedestal Tables



4SPT Series Table - 6" Square Tube Frame

- 6" Square Pedestal 2 1/2" square tube arms
- 48" Square Top
- Heavy center cross braces
- Powder coated black
- Surface mount add "SM" add \$36.00 to price
- Add \$40.00 for Galvanized Frame.

4SPTC	Frame only 48" x 48"	256 Lbs	\$ 579.00
4SPTCW	Treated SYP Wood 48" x 48"	367 Lbs	\$ 869.00
4SPTCA	Aluminum 48" x 48"	321 Lbs	\$ 904.00
4SPTCF	Fiberglass 48" x 48"	391 Lbs	\$ 1,139.00
4SPTCVP	Vinyl Plastisol (PVC) 46" x 46"	393 Lbs	\$ 1,262.00
4SPTCRP	Recycled Plastic 48" x 48"	435 Lbs	\$ 1,058.00

4SPTGVPSM
Plastisol



Backrest Available
Pg 16



Octagon Top

Octagon Top Table - 6" Square Tube Frame

- 6" Square Pedestal 2 1/2" square tube arms
- 48" Square Top
- Heavy center cross braces
- Powder coated black
- Surface mount add "SM" add \$36.00 to price
- Add \$40.00 for Galvanized Frame.

4SPTCFO	Fiberglass 48" x 48"	396 Lbs	\$ 1,163.00
4SPTCVPO	Vinyl Plastisol (PVC) 46" x 46"	398 Lbs	\$ 1,286.00



6SPTGASM
Aluminum

6SPT Series Table

- 6" Square Pedestal 2 1/2" tube arms
- Surface mount add "SM" add \$36.00 to price
- Add \$50.00 for Galvanized Frame.

6SPTC	Frame only	212 Lbs	\$ 511.00
6SPTCW	6' Treated SYP Wood	332 Lbs	\$ 723.00
6SPTCA	6' Aluminum	264 Lbs	\$ 764.00
6SPTCF	6' Fiberglass	343 Lbs	\$ 1,065.00
6SPTCVP	6' Vinyl Plastisol (PVC)	378 Lbs	\$ 1,193.00
6SPTCRRP	6' Recycled Plastic	430 Lbs	\$ 1,191.00



RSPTCVPSM
Plastisol

RSPTGVP Series- Round Vinylast Plastisol Table

- 6" Square Pedestal 2 1/2" square tube arms
- Powder coated black
- Surface mount add "SM" add \$36.00 to price
- Add \$40.00 for Galvanized Frame.

RSPTCVP	Plastisol - Single Post	402 Lbs	\$ 1,362.00
RSPTCF	Fiberglass - Single Post	402 Lbs	\$ 1,220.00
RSPTCVPADA	ADA	380 Lbs	\$ 1,326.00



Recycled Plastic:

Brown Cedar Gray
Steel Reinforced

Plank Color Options For Page 14 & 15



Than Thermoplastic

Quality Thick Vinyl Plastisol:

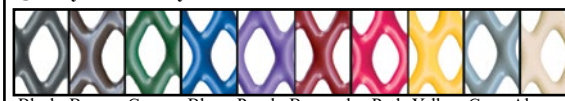

Black Brown Green Blue Purple Burgundy Red Yellow Gray Almond

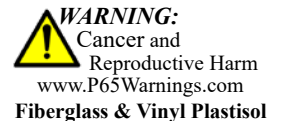

WARNING:
Cancer and
Reproductive Harm
www.P65Warnings.com
Fiberglass & Vinyl Plastisol



**RTRCVP
Plastisol**



**Green & Black
Vinyl Plastisol Only**

RTRVP Series Table - Round Vinylast Plastisol

- 1 5/8" O.D. Pipe
- 48" Diameter Top
- PVC coated #9 expanded metal
- Frame galvanized after fabrication or powder coated black
- Umbrella hole



Than Thermoplastic

RTRCVP	Black Frame	354 Lbs	\$ 1,121.00
RTRGVV	Galv. Frame	354 Lbs	\$ 1,121.00
RTRCVPADA	Black Frame ADA	336 Lbs	\$ 1,037.00
RTRGVVADA	Galv. Frame ADA	336 Lbs	\$ 1,037.00



**RTRCF
Fiberglass**

RTRF Series Table - Fiberglass

- 1 5/8" O.D. Pipe
- 48" Diameter Top
- Fiberglass top & seats coated with Ultragel
- Frame galvanized after fabrication or powder coated black
- Umbrella hole - **add- "HL"** to model number

RTRCF	Black Frame	255 Lbs	\$ 872.00
RTRGF	Galv. Frame	255 Lbs	\$ 872.00
RTRCFADA	Black Frame ADA	180 Lbs	\$ 818.00
RTRGFADA	Galv. Frame ADA	180 Lbs	\$ 818.00

Custom Game Top Shown

*Chess Pieces
Not Included*



Logo Inlay
Additional
Cost

RTRFVPS Series Table - Fiberglass/Vinylast Plastisol

- 1 5/8" O.D. Pipe
- 48" Diameter Top
- Fiberglass top coated with Ultragel
- PVC seats coated #9 expanded metal
- Frame galvanized after fabrication or powder coated black
- Umbrella hole - **add- "HL"** to model number

RTRCFVPS	Black Frame	402 Lbs	\$ 1,065.00
RTRGFVPS	Galv. Frame	402 Lbs	\$ 1,065.00
RTRCFVPSADA	Black Frame ADA	376 Lbs	\$ 994.00
RTRGFVPSADA	Galv. Frame ADA	376 Lbs	\$ 994.00

RTR3CFVPS 36" Top Table - Fiberglass/Vinylast Plastisol

RTR3CFVPS	Black Frame	235 Lbs	\$ 947.00
RTR3GFVPS	Galv. Frame	235 Lbs	\$ 947.00



Customize Your Tables
Call For Pricing

Fiberglass:

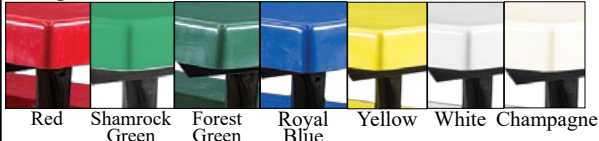

WARNING:
Cancer and
Reproductive Harm
www.P65Warnings.com

Umbrella Stabilizer Brace
on Round table frames.



Square, Octagon Tables and Back Rests



4SJCF
Fiberglass

4SJ Series- 1 5/8" O.D. "J" Style Frame

- 1 5/8" O.D. Pipe
- Heavy center cross braces
- Frame galvanized after fabrication 'G' or powder coated black 'C'
- Fiberglass umbrella hole - add- "HL" to model number

4SJC	Frame Only	108 Lbs	\$ 368.00
4SJCW	SYP Wood- 48"x48"	234 Lbs	\$ 637.00
4SJCA	Aluminum- 48"x48"	168 Lbs	\$ 756.00
4SJCF	Fiberglass- 48"x48"	238 Lbs	\$ 935.00
4SJCVP	Vinyl Plastisol (PVC)	349 Lbs	\$ 1,088.00
4SJC RP	Recycled Plastic	338 Lbs	\$ 933.00



4SJCVP0
Plastisol



6OVPT
Plastisol

Octagon Top- 1 5/8" O.D. "J" Style Frame

- 1 5/8" O.D. Pipe
- Heavy center cross braces
- Frame powder coated black 'C'
- Fiberglass umbrella hole - add- "HL" to model number

4SJCFO	Fiberglass 48" x 48"	243 Lbs	\$ 935.00
4SJCVP0	Vinyl Plastisol (PVC) 46" x 46"	354 Lbs	\$ 1,128.00

Oval Table- Vinyl Plastisol

- 1 7/8" O.D. Pipe Frame
- No. 9 expanded metal
- Entire table is plastisol coated

6OVPT	6' Oval Table	255 Lbs	\$ 1,133.00
-------	---------------	---------	-------------

Fiberglass:

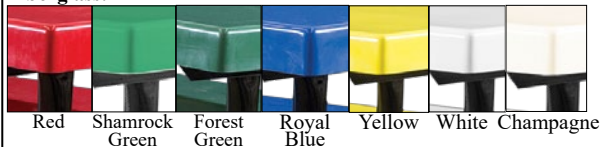

Recycled Plastic:



Quality Thick Vinyl Plastisol:

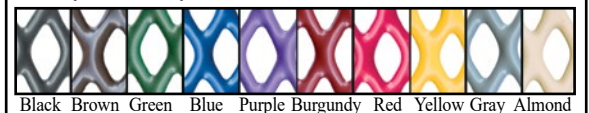

Backrests- Optional

- One pair of brackets with one 36" long backrest plank.

BackrestW	Treated SYP Wood	36 Lbs	\$ 86.00
BackrestA	Aluminum	30 Lbs	\$ 116.00
BackrestF	Fiberglass	40 Lbs	\$ 128.00
BackrestVP	Vinyl Plastisol (PVC)	30 Lbs	\$ 183.00
BackrestRP	Recycled Plastic	43 Lbs	\$ 129.00



WARNING:

Cancer and
Reproductive Harm

www.P65Warnings.com
Fiberglass & Vinyl Plastisol



BackrestW
SYP Wood

Choose plank and frame colors when ordering

Child Sized Tables

Rectangle Child Size- 1 5/8" O.D.

- 1 5/8" O.D. Pipe Frame
- Plastisol coated 3/4" No. 9 expanded metal
- Choose powder coat frame: black, blue, red, yellow or green

4CSVPT	4' Table	140 Lbs	\$ 718.00
6CSVPT	6' Table	175 Lbs	\$ 896.00
8CSVPT	8' Table	198 Lbs	\$ 1,098.00



**6CSVPT
Plastisol**

Square Child Size- 48" Square

- 1 5/8" O.D. Pipe Frame
- Plastisol coated 3/4" No. 9 expanded metal
- Choose powder coat frame: black, blue, red, yellow or green

CS4SJCW	48" Sq. Syp Wood	224 Lbs	\$ 603.00
CS4SJCA	48" Sq. Aluminum	158 Lbs	\$ 728.00
CS4SJCF	48" Sq. Fiberglass	228 Lbs	\$ 934.00
CS4SJCVP	46" Sq. Vinyl Plastisol	239 Lbs	\$ 1,087.00
CS4SJCRP	48" Sq. Recycled Plastic	292 Lbs	\$ 932.00



**CS4SJCVP
Plastisol**

Quality Thick Vinyl Plastisol:

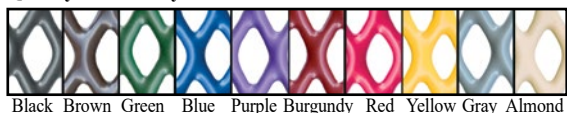

Than Thermoplastic

Round Vinyl Plastisol Child Size- 1 5/8" O.D.

- 1 5/8" O.D. Pipe Frame
- Plastisol coated 3/4" No. 9 expanded metal
- Choose powder coat frame: black, blue, red, yellow or green

CSRTRGVP	48" Dia top Galv. Frame	325 Lbs	\$ 1,119.00
CSRTRCVP	48" Dia top Pwder Coated	325 Lbs	\$ 1,119.00



**CSRTRCVP
Plastisol**

Impact Absorbing, Kid Friendly Coating!

Round Fiberglass Child Size- 1 5/8" O.D.

- 1 5/8" O.D. Pipe Frame
- Fiberglass top & seats coated with Ultragel
- Choose powder coat frame: black, blue, red, yellow or green

CSRTRGF	48" Dia top Galv. Frame	169 Lbs	\$ 855.00
CSRTRCF	48" Dia top Powder Coated	169 Lbs	\$ 855.00

Fiberglass:

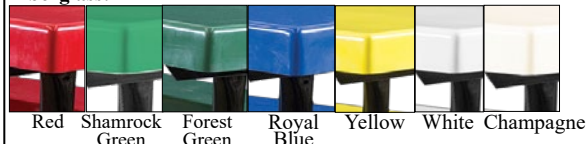

**CSRTRCF
Fiberglass**

WARNING:
Cancer and
Reproductive Harm
www.P65Warnings.com
Fiberglass & Vinyl Plastisol

Umbrellas



Patio Umbrellas Wind Resistant

- 6 or 8 fiberglass ribs
- 3/8" Dia.
- 7 1/2' and 9' diameter
- 1 1/2" 2 piece aluminum pole white or bronze finish
.065 wall thickness
- Crank lift mechanism included
- No Tilt

UHM70C 7 1/2' Spun Acrylic, crank lift 16 Lbs \$ 169.00

UHM90C 9' Spun Acrylic, crank lift 17 Lbs \$ 194.00

Olefin Fabric Colors



Detail of Crank

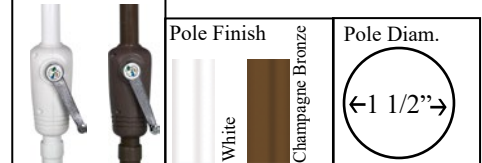

**Durable
Fiberglass
Ribs!**



Garden Valance 6 Rib Wind Resistant

- 6 fiberglass ribs
- 3/8" Dia.
- 7 1/2' diameter
- 1 1/2" 2 piece aluminum pole white or bronze finish
.065 wall thickness
- Textilene Fabric
- Crank mechanism
- No Tilt

UVFL7-TC 7 1/2 ft Textilene crank 15 Lbs \$ 148.00

Colors:

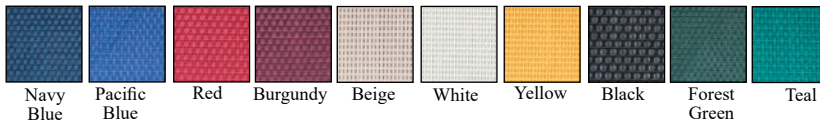

Market Octagon 8 Rib Wind Resistant

- 8 fiberglass ribs
- 1/2" Diam.
- 7 1/2', 9' or 11' diameter
- 1 1/2" 2 piece aluminum pole white or bronze finish .080 wall thickness
- Crank, push up or pulley and pin
- No Tilt

UOM7MC	7 1/2' Marine grade fabric, crank	17 Lbs	\$ 345.00
UOM7MU	7 1/2' Marine grade fabric, push up	17 Lbs	\$ 345.00
UOM9MC	9' Marine grade fabric, crank	19 Lbs	\$ 406.00
UOM9MP	9' Marine grade fabric, pulley & pin	19 Lbs	\$ 422.00
UOM11MP	11' Marine grade fabric, pulley & pin	20 Lbs	\$ 508.00

Marine Grade Fabric Colors:



Detail of Crank

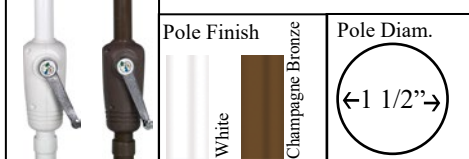

Detail of Hub

Commercial Ultra Heavy Wind Resistant

- 8 fiberglass ribs
- 1/2" Dia.
- 8', 9' or 11' diameter
- 1 1/2" 1 piece aluminum pole white or bronze finish .125 wall thickness
- Push up or pulley and pin
- No Tilt

ULP7MU	8' Marine grade fabric, push up	15 Lbs	\$ 479.00
ULP9MU	9' Marine grade fabric, push up	17 Lbs	\$ 565.00
ULP11MP	11' Marine grade fabric, pulley & pin	26 Lbs	\$ 645.00

Marine Grade Fabric Colors:



Champagne Bronze Pole

Note: Alternating colors are available. Add "A" to model and 10% to price.



Detail of Hub

5 Year Warranty!

5 Year no fade fabric warranty!

Wind Resistant Umbrellas

Specially designed for windy conditions. A wind vent in the top lets air out and 'fishing pole type fiberglass ribs will flex with the wind, but do not break! They come with powder coated aluminum poles. Tops are easily changed - buy- extra tops to quickly change your color scheme! Ask rep for pricing.

Umbrellas & Umbrella Bases



Fiberglass:

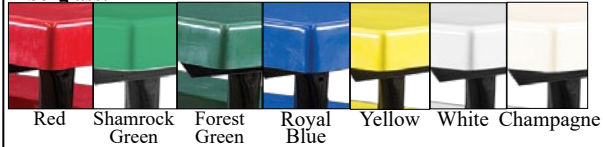

Fiberglass Umbrellas

- Weather-resistant fiberglass
- 7 1/2 ft diameter
- 1 1/2" Pole
- Ultragel coating 20 mils UV inhibitors

UF Fiberglass w/pole swivels 81 Lbs \$ 499.00



WARNING: Cancer and Reproductive Harm www.P65Warnings.com

Concrete Bases

- 19" diameter
- 7 1/2' and 9' diameter umbrellas only
- Powder coated black finish
- 14" sleeve height 1 1/2"- 1 3/4" diameter

UBCW	White concrete base	50 Lbs	\$ 65.00
UBCC	Bronze concrete base	50 Lbs	\$ 65.00
UBCB	Beige concrete base	50 Lbs	\$ 65.00



This base does not fit under Thermoplastic or Hex Tables

Heavy-Duty Steel Bases

- 30" square thick steel
- Black powder coat finish over galvanized steel
- 12 1/2" sleeve height 2" diameter



UBSL30	Umbrella base	200 Lbs	\$ 551.00
UBSL30W	Umbrella base w/wheels	210 Lbs	\$ 632.00

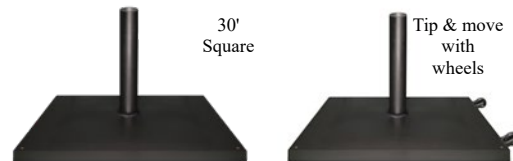

U Brace Umbrella Anchor

- Prevents umbrella from coming out
- No maintenance
- Attaches to umbrella pole underneath table top
- Stainless steel
- Ships UPS

UBRACE Anchor 2 Lbs \$ 29.00

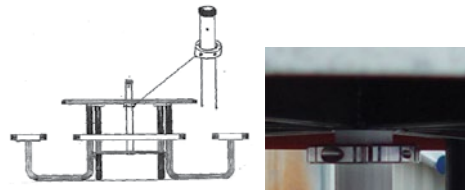



SBD60035

- Dual 302 Sq. Inch Cook Surface
- 1/2" Rods on 1" Centers
- 3/16" Steel Body
- 3 1/2" Galvanized Pedestal
- Rotates 360 Degrees
- Optional Utility Shelf
- Dual 4 Position Cook Surface
- Vandal Resistant
- High Heat Paint or Hot Dip Galvanized Fire box

Dual 302 Sq. Inch Cook Sp.
360° Rotation
Dual 4 Position Cooking Surface
3 1/2" Pedestal

SBD60035	Standard (3 1/2") Ped.	140 Lbs	\$ 342.00
UT	Optional utility shelf	10 Lbs	\$ 21.00



SB400

- 392 Sq. Inch Cook Surface 14"x28"
- 1/2" Rods on 1" Centers
- 3/16" Steel Body
- 2 3/8" or 3 1/2" Galvanized Pedestal
- Rotates 360 Degrees
- Optional Utility Shelf
- 4 Position Cook Surface
- Vandal Resistant
- High Heat Paint

392 Sq. Inch Cook Sp.
360° Rotation
4 Position Cooking Surface
2 3/8" or 3 1/2" Pedestal

SB400	Standard (2 3/8") Ped.	101 Lbs	\$ 214.00
SB40035	Grill with 3 1/2" Ped.	110 Lbs	\$ 235.00
UT	Optional utility shelf	10 Lbs	\$ 21.00



300 Sq. Inch Cook Sp.
360° Rotation
4 Position Cooking Surface
2 3/8" or 3 1/2" Pedestal

SB16FI Flat Iron Grill

- 300 Sq. Inch Cook Surface 15"x20"
- 3/16" Steel Body
- 2 3/8" or 3 1/2" Galvanized Pedestal
- Rotates 360 Degrees
- Optional Utility Shelf
- 4 Position Cook Surface
- Vandal Resistant
- High Heat Paint



SB16FI	Standard 2 3/8" Ped.	79 Lbs	\$ 197.00
SB16FI35	Grill with 3 1/2" Ped.	88 Lbs	\$ 218.00
UT	Optional utility shelf	10 Lbs	\$ 21.00

*Cooking Surface
Cut From Single Piece of
5/16" Steel Plate*

**Entire Page
WARNING:**
Cancer and
Reproductive Harm
www.P65Warnings.com



*Call For
Your Personalized
Grates!*

Pedestal Grills

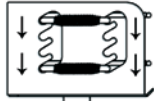

SB16 Grill

- 300 Sq. Inch Cook Surface 15"x20"
- 1/2" Rods on 1" Centers
- 3/16" Steel Body
- 2 3/8" or 3 1/2" Galvanized Pedestal
- Rotates 360 Degrees
- Optional Utility Shelf
- 4 Position Cook Surface
- Vandal Resistant
- High Heat Paint or
- Hot Dip Galvanized Fire box

SB16	Standard (2 3/8") Ped.	79 Lbs	\$ 174.00
SB16G	Galv. body	79 Lbs	\$ 232.00
SB1635	3 1/2" Ped.	88 Lbs	\$ 195.00
SB1635G	3 1/2" Ped. & gal. body	88 Lbs	\$ 254.00
UT	Optional utility shelf	10 Lbs	\$ 21.00
UTG	Optional galv. utility shelf	10 Lbs	\$ 24.00



Grate
28"-34"

SB16ADA Wheel Chair Accessible Grill

- 300 Sq Inch Cook Surface 15"x20"
- 1/2" Rods on 1" Centers
- 3/16" Steel Body
- 2 3/8", or 3 1/2" O.D. Galvanized Pedestal
- Rotates 360 Degrees
- Easy Swivel Cook Surface
- High Heat Paint

SB16ADA	2 3/8" Pedestal Grill	80 Lbs	\$ 215.00
SB16ADA3.5	3 1/2" Pedestal Grill	89 Lbs	\$ 239.00



ADA Pedestal Grill



WARNING: Cancer and Reproductive Harm www.P65Warnings.com



SF16 Grill

- All the features of the SB16 with the added feature of a flip back cook surface.

SF16	Standard (2 3/8") Ped.	79 Lbs	\$ 177.00
SF16G	Galv. body	79 Lbs	\$ 235.00
SF1635	3 1/2" Ped.	88 Lbs	\$ 199.00
SF1635G	3 1/2" Ped. & gal. body	88 Lbs	\$ 257.00
UT	Optional utility shelf	10 Lbs	\$ 21.00
UTG	Optional galv. utility shelf	10 Lbs	\$ 24.00

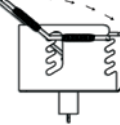

Hot Dip Galvanized Body
SB16 and SF16 only are available with hot dip galvanized body. Cooking grate coated with black high heat paint. Please add "G" to model number.



Grill Cover
Black Vinyl Cover with drawstring closure fits standard pedestal grills.
PGCOVER 2 Lbs \$ 42.00



Utility Shelf
Utility Shelf - 8" x 20" x 3/16" bolts onto rear. Available for grills above. Model "UT" is painted black and model "UTG" is galvanized. Not available for ADA Pedestal **SB16ADA**



Surface Mount
To add surface mount to any grill on this page add "SM" to model number and \$20 to price.



**Room to Cook Enough
Food For a
Family Reunion!**

SPD450 - Large Group Grill

- 1368 Sq Inch Cook Surface 38"x36"
- 1/2" Rods on 1" Centers
- 3/16" Steel Body
- 6" Square Pedestal (Anchors Included)
- 12"x36" Bolt On Utility Shelf
- Adjustable 4 Position Fire Grate
- Flip up Grates for Easy Fire Building
- High Heat Paint

SPD450	Standard w/1 shelf SM	460 Lbs	\$ 906.00
SPD450IG	In ground mount	460 Lbs	\$ 947.00
SPDUT	Additional shelf	29 Lbs	\$ 43.00



WARNING: Cancer and Reproductive Harm www.P65Warnings.com



SB3628U - Medium Group Grill



- 1008 Sq Inch Cook Surface 28"x36"
- 1/2" Rods on 1" Centers
- 3/16" Steel Body
- 6" Square Pedestal (Anchors Included)
- 10"x28" Bolt On Utility Shelf
- 2 Separately Adjustable Cook Surfaces
- High Heat Paint

SB3628U	Standard (6" sq ped) SM	246 Lbs	\$ 521.00
SB3628UIG	In ground mount	266 Lbs	\$ 559.00



XB16 - Small Group Grill

- 860 Sq Inch Cook Surface 18"x 48"
- 1/2" Rod on 1" Centers
- 3/16" Steel Body
- Two 2 3/8" O.D. Galvanized In Ground Posts
- 4 Position Adjustable Cook Surface
- High Heat Paint

XB16	Standard (2 peds) IG	197 Lbs	\$ 448.00
XB16SM	Surface Mount	177 Lbs	\$ 484.00



Covered Grills & Hot Ash



←
Shown with
Optional Warming
Basket



Only for
ECG1929
ECG1941

Covered Grills

- 320 or 500 Sq. In Cook Surface
- 1/2" dia. Non removable steel cooking grates
- 14 ga. Sheet Steel
- 10 ga. steel plate fire box
- 11 ga. steel end panels
- 360 degree rotation heat and smoke control
- 3 1/2" O.D. pedestal
- High heat, non-toxic, black enamel
- Utility Shelf included

ECG1929	320 Sq. in 19.5"x29.25"x16.5"	155 Lbs	\$ 516.00
ECG1941	500 Sq. in 19.5"x41.5"x16.5"	198 Lbs	\$ 672.00
ECPCB	Optional portable casters	29 Lbs	\$ 95.00
ECQB29	Optional warming basket	16 Lbs	\$ 45.00
ECQB41	Optional warming basket	12 Lbs	\$ 55.00



WARNING: Cancer and Reproductive Harm www.P65Warnings.com



Ash Shovel

ASHSHOVEL Ash Shovel 1 Lbs **\$ 19.00**



Recommended for any public picnic grounds where charcoal grills are being used!



Steel Coal Ash Receptacle

- 23" Square top funnels to 12"
- Holds 32 gallon trash
- Or let goals fall to concrete slab

KPHCB	23" Square Recept.	90 Lbs	\$ 382.00
CG32HDNL	32 Gal Galv. Can 25 gauge	15 Lbs	\$ 74.00
KPHCBSM	Surface mount	5 Lbs	\$ 16.00
KPHCBANCH	Ground Anchors	3 Lbs	\$ 20.00



	Smooth	Light Sand Blast	Perma Stone	Dura Brite
Dove Gray				
Terra Cotta				
Light Brown				
Sand Tan				

Hot Ash Receptacle

- 22"sq. x 35" tall
- Welded steel bars on top
- Select color and texture when ordering

CHAR2235 650 Lbs **\$ 515.00**

Select Texture: Smooth, Light Sand Blast, Perma Stone or Durabrite
Select Color: Dove Gray, Terra Cotta, Light Brown or Sand Tan

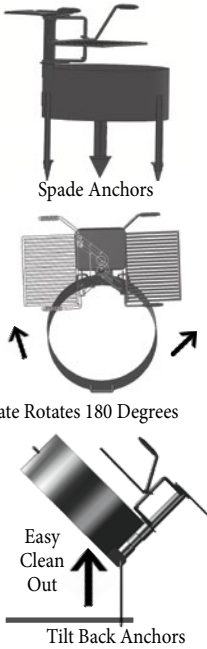

Grate adjust-ability means you can put the heat where you want it!



12" High Sides

30" Diameter

UFR30 Creates the Ultimate Cooking Experience!

UFR30 "The Ultimate" Fire Ring

- 300 Sq. Inch Cook Surface 15"x20"
- 1/2" Rods on 1" Centers
- 30" Diameter
- 12" High Sides
- Grate Swings 180 Degrees
- Integrated Utility Shelf
- Cool Spring Handles
- Vandal Resistant
- High Heat Paint & Rust-Resistant Black Enamel

UFR30TB	UFR30 Tilt back staples	116 Lbs	\$ 306.00
UFR30SAS	UFR30 Spade anchors	121 Lbs	\$ 328.00



30" Diameter



Flip - Up Grate
Flips out of the way!

FR30 Fire Ring

- 300 Sq. Inch Cook Surface 15"x20 grate
- 1/2" Rods on 1" Centers
- 30" Diameter
- 3/16" thick steel
- "TB" = tilt back hinges
- "SAS" = spade anchors
- Cool Spring Handles
- 4 Heights Available

FR730TB	7" High tilt back staples	69 Lbs	\$ 153.00
FR730SAS	7" High spade anchors	74 Lbs	\$ 177.00
FR930TB	9" High tilt back staples	88 Lbs	\$ 168.00
FR930SAS	9" High spade anchors	95 Lbs	\$ 192.00
FR1130TB	11" High tilt back staples	105 Lbs	\$ 206.00
FR1130SAS	11" High spade anchors	116 Lbs	\$ 215.00
FR1830WCSAS	18" High Sides ADA Compliant fire ring	130 Lbs	\$ 285.00



WARNING:
Cancer and
Reproductive Harm
www.P65Warnings.com



34" Diameter

AFG80 Fire Ring

- 300 Sq. Inch Cook Surface 15"x20"
- 1/2" Rods on 1" Centers
- 34" Diameter
- 6" High Sides (18" High Sides for ADA)
- 4 Adjustable Cooking Heights
- Reinforcing Angle Across Pit
- Cool Spring Handles
- Vandal Resistant
- High Heat Paint & Rust-Resistant Black Enamel
- AFG80WCSAS is ADA compliant

AFG80TB	AFG80 Tilt back staples	86 Lbs	\$ 174.00
AFG80SAS	AFG80 Spade anchors	91 Lbs	\$ 198.00
AFG80WCSAS	ADA Compliant fire ring	167 Lbs	\$ 303.00

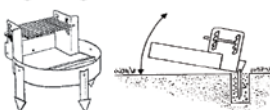

Fire Ring Anchor Options:

ADA units
have spade
anchors



Dogipot Pet Waste Disposal System - 2 Year Ltd Warranty



Dispenser Only



Dispenser Only



Dispenser Only



Dogipot Poly Station

- Forest Green Poly Dispenser
- Forest Green 10 gal Poly Trash Receptacle
- Snap on Lid (holds bag in place)
- 2" x 2" x 4'-8" poly telescopic mounting post with installation hardware
- Clearly Printed Instructions on Top
- Locked Bottom Compartment
- Aluminum DOGIPOT Pet Sign (Choice of On or Off leash)
- 2 Litter Bag Rolls @ 200 Bags Each
- 50 Ten Gal. Trash Liner Bags
- Mounting Hardware

KDP1010 Poly station, complete 23 Lbs \$276.00

Dogipot Pet Station

- 15.5" x 9.4" x 3.25" Aluminum Bag Dispenser
- Locking Front Access Panel
- Clearly Printed Instructions
- "Please clean up after your dog"
- 2 Rolls (200 ea.)
- 8" Telescoping Gal. Steel Post for Direct Bury
- 10 Gallon Steel Trash Receptacle with Lid
- 50 Heavy-duty Drawstring Trash Liner Bags
- 12" x 18" Aluminum DOGIPOT Pet Sign (Choice of On or Off leash)

KDP1003 Pet station, complete 62 Lbs \$418.00

KDP1003BLK Black Complete Station 62 Lbs \$418.00

Dogipot Header Station

- Aluminum DOGIPOT Pet Sign (Choice of On or Off leash)
- 15.5" x 9.4" x 3.25" Aluminum Bag Dispenser
- 12 Gauge Aluminum
- Powder Coated Forest Green
- Clearly Printed Instruction on Top
- 4-100CT Cards
- 10 Gallon Steel Trash Receptacle with stainless steel lid. (Can be upgraded to include the all Aluminum Trash)
- Box of 50 Count Liner Trash Bags
- Mounting Hardware

KDP1003HP Junior Header Station 29 Lbs \$435.00

KDP1003HPBLK Black Header Station 29 Lbs \$435.00

Dogipot Poly-Dispenser Only

- 17" x 9.4" x 3.25" Poly Bag Dispenser
- Locking Front Access Panel
- Forest Green 2.5 mm Poly Dispenser
- Clearly Printed Instructions on Top
- 2 Diamond Bag Dispenser Slots
- 400 Litter Bags Installed
- Mounting Hardware

KDP1007 Poly, dispenser only 6 Lbs \$92.00

Dogipot-Dispenser Only

- 15.5" x 9.4" x 3.25" Aluminum Bag Dispenser
- Locking Front Access Panel
- Clearly Printed Instructions
- "Please clean up after your dog"
- 400 Litter Bags Installed
- Mounting Hardware

KDP1002 Junior, dispenser only 8 Lbs \$116.00

Dogipot Header-Dispenser Only

- 15.5" x 9.4" x 3.25" Aluminum Bag Dispenser
- Locking Front Access Panel
- 12 Gauge Aluminum
- Powder Coated Forest Green
- Clearly Printed Instruction on Top
- 4-100CT Cards
- Mounting Hardware

KDP1002HP Junior, dispenser only 9 Lbs \$124.00

Dogipot Bags

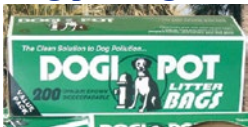

Brown litter bags come in 10, 20 or 30 roll cases of 200 ct each roll. (10 roll case is 2,000 total bags, less than 5 cents each!)

KDP140210 12 Lbs \$91.00
KDP140220 24 Lbs \$172.00
KDP140230 36 Lbs \$254.00

Header Packs



- Fits header dispenser
- 100 Bags per Header Pack
- 20 Header Packs Per Case
- Clearly Printed Instructions on each header pack
- Perforated Tear Away Bag

KDP1402HP20 1 Header Case 10 Lbs \$97.00

Trash liner bags - 50 Heavy-duty 10 gallon drawstring bags. (50 total bags, less than 44 cents each!)

KDP1404 6 Lbs \$22.00

Mutt Mitt Refill Card

Mutt Mitt Refills - 10 cards per case, 80 Mitts stapled to a card. (800 Mitts). Each of 2 plys 1.0 mil thick. Made in U.S.A.

MMREFILLS 2 Ply 18 Lbs \$79.00

More

Mutt Mitt

Online!



A.

Triple Hoop Jump

- 46”L x 39”H
- 3 Hoops
- 1/2” Rods
- Puppy, Kay and Doghouse Logos
- Powder Coated Frame



B.

Double Hoop Jump

- 46”L x 34” H
- 2 Hoops
- 1/2” Rods
- Puppy and Kay Logos
- Powder Coated Frame



C.

Dog Tunnel

- HDPE with UV Stabilizer
- 12” Galvanized tie down stakes
- Aluminum Anchors
- Outside 37”H x 41”W x 61”L
- Flat Tunnel Bottom w/Traction Panels
- Material is resistant to most chemical to make clean up is easy.



A. 3 Hoop Jump	20 Lbs	K9P3H	\$ 333.00
B. 2 Hoop Jump	18 Lbs	K9P2H	\$ 259.00
C. Dog Tunnel	105 Lbs	K9PDT	\$ 1,152.00
D. Dog Peak Ramp	254 Lbs	K9PDR	\$ 1,544.00
E. Leash Post	32 Lbs	K9PLP	\$ 202.00
F. Platform	82 Lbs	K9PPT	\$ 389.00
G. Fire Hydrant	46 Lbs	K9PFH	\$ 352.00



D.

Dog A Ramp

- 118”L x 28” W x 40”H
- 1 1/2” X 3/16” Steel Angle Plank Support
- 1 5/8” Tubular Uprights
- Black Powder Coated Frame



E.

Leash Post

- 36” High
- 2 3/8” Steel Tube
- 1/2” Rod Leash Holder
- Surface mount plate w/stakes
- Powder Coated Frame



F.

Platform

- 36” Square x 12” High
- Cedar Recycled Plastic Planks
- 1 1/2”x 3/16” Steel Angle Plank Support
- 1 5/8” Tubular Uprights
- Black Powder Coated Frame



G.

Fire Hydrant

- 25”H X 16”W
- 6” Round Steel Tube
- 4” Round Arms
- Red Powder Coated

Litter Receptacles



132 LR Series

- 32 gal each
- Engraved tops
- 2" x 4" slats available
- Recycled plastic or
- Pressure Treated Yellow Pine
- Lids & Liners sold separately

	Freestanding			Surface Mount			In Ground		
Frame Only	132LRP	36 Lbs	\$92.00	132LRSM	39 Lbs	\$127.00	132LRIG	42 Lbs	\$108.00
Southern Yellow Pine Slats	132LRSYPP	98 Lbs	\$247.00	132LRSYPSM	111 Lbs	\$284.00	132LRSYPIG	114 Lbs	\$258.00
Recycled Plastic Slats	132LRPP	102 Lbs	\$406.00	132LRPPSM	105 Lbs	\$443.00	132LRPPIG	108 Lbs	\$415.00

Southern Yellow Pine Slats



Best Selling Litter Receptacle



Galvanized Dome Lid
DLG55
23 3/4" ID, 12 Lbs
\$166.00



Plastic Dome Lid
DLMP32-55
24" ID, 10 Lbs
\$99.00

Plastic Dome Colors:
Blue
Red
Yellow
Grey
Brown
Black



CP32
11 Lbs
\$36.00



CG32
13 Lbs
\$69.00



CG32LID
3 Lbs
\$11.00



Triple Round Bin Recycling Center w/post

- 96 Gallon Total
- 32 gal each
- Engraved tops
- 1" x 4" slats available
- Gray, Cedar and Green
- Recycled post included
- Liners sold separately

JP3RRC	3-Round Center w/post	230 Lbs	\$1,585.00
JP32LINER	32 gal. Liner	6 Lbs	\$58.00



Square Bin Recycled Plastic Recycling Container

- 32 gal
- Engraved tops
- 1" x 4" slats
- Gray, Cedar and Green
- Liners sold separately
- Specify - Glass, Cans, Bottles Paper, Plastic, etc.
- Place multiple squares side by side to create a recycling center

JP32SRC	32 Gallon Receptacle	90 Lbs	\$487.00
JP32LINER	32 gal. Liner	6 Lbs	\$58.00



*Recycling Do Your Part
Keep It Green*

CPW Can Posts

CPW timber canpost is a 6" x 6" post in a treated pine or recycled plastic post for direct bury. Powder coated steel arms support cans at handle and bottom. Chains are provided to prevent loss of lid. Holds 32 or 20 gallon cans that are sold separately.

CPW-S	Single side wood holder	56 Lbs	\$99.00
CPW-D	Double side wood holder	62 Lbs	\$128.00
CPH-D	Double side hardware only	20 Lbs	\$72.00
CPRP-S	Single side recycled plastic holder	71 Lbs	\$178.00
CPPR-D	Double side recycled plastic holder	77 Lbs	\$219.00
CPH-S	Single side hardware only	10 Lbs	\$37.00
CG32	32 Gallon Can	13 Lbs	\$69.00
CG32LID	32 Gallon Lid	3 Lbs	\$11.00
CG20	20 Gallon Can	11 Lbs	\$66.00
CG20LID	20 Gallon Lid	3 Lbs	\$9.00



CPPR-D
(Shown with two 32 gallon can and lids)

Tippy Trash

- 52 Gallon
- 2-3/8" O.D.
- Powder Coated Steel
- Unlock and tip
- Custom lettering on solid band
- Black, Brown, or Green

TT52IG	52 Gal. In Ground	110 Lbs	\$491.00
TT52SM	52 Gal. Surf. Mt	100 Lbs	\$491.00
TT52LID	27 Inner Dome Lid	12 Lbs	\$139.00



52 Gallon
Unlock, Tip and Go!

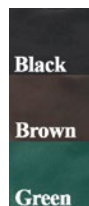

Steel Mesh Basket

Designed to withstand constant use and harsh weather conditions. See-through mesh means they don't blow over easily in strong winds and the tapered design permits nesting for storage. These baskets will hold up to 52 gallons of trash in a light weight basket which is ideal for high traffic area where trash must be emptied often. These units feature reinforced steel edges and bottom drain holes. Specify your choice of galvanized (silver), or powder coat (C) color (green, red, black, or blue) when ordering. 23" O.D. at top.

SMTB52	52 gal. galv. mesh basket	31 Lbs	\$264.00
SMTB52C	52 gal. pc. mesh basket	31 Lbs	\$245.00



Litter Receptacles



Beige Granite

Light Granite

Dark Granite

TUFFCAN Round 42 Gallon

- 42 Gallon
- 25" Diameter
- Virtually Indestructible
- Beige Granite
- Light Granite or
- Dark Granite

TC42LRD	42 Gal. Dome Top	25 Lbs	\$ 281.00
TC42LRH	42 Gal. 10" Hole Top	25 Lbs	\$ 260.00



Shown in Light Granite

**NO Rust,
Crack or Fade!**



Shown in Beige Granite



TUFFCAN Square, w/Dome Lid

- 32 Gallon
- 18"x18"x38"
- Rigid molded resin
- Complete with hole top
- Unique slatted appearance

TC32LRD	32 Gal. w/Dome Lid	31 Lbs	\$ 305.00
----------------	--------------------	--------	------------------



**Rigid Molded Resin:
Unique & Durable**

Shown in Dark Granite



TUFFCAN Square 32 Gallon

- 32 Gallon
- 18"x18"x38"
- Rigid molded resin
- Complete with hole top
- Unique slatted appearance

TC32LRH	32 Gal. w/Hole Top	25 Lbs	\$ 286.00
----------------	--------------------	--------	------------------

32 gal Round Plastisol



32 gal. Round Receptacle of No. 9 expanded metal with thick plastisol coating is very popular.



Plastic Liners
CP32
11 Lbs \$36.00

132LRVP
Yellow

132LRVP 32 Gal. Freestanding 70 Lbs \$316.00
132LRVPIG 32 Gal in ground 70 Lbs \$316.00
132LRVPSM 32 Gal surface mount 70 Lbs \$316.00

132LRVP Lids



Steel 8" Hole
FLS8-32
17Lbs \$115.00



Steel 16" Hole
FLS16-32
12Lbs \$115.00

132LRVP & 155LRVP Lids



Recycle Dome
DLMP32-55P
24" ID,
10 Lbs \$99.00
Blue Only



Plastic Dome
DLMP32-55
24" ID,
10 Lbs \$99.00

Plastic Dome Colors:

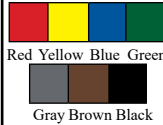

55 gal Round Plastisol

55 gal. Round Receptacle is ideal to hold and conceal 55 gal barrels PVC coated no.9 expanded metal.

Holds
55 gal.
Drums
(Not Sold)



155LRVP
Black

155LRVP 55 Gal. Freestanding 120 Lbs \$335.00
155LRVPIG 55 Gal in ground 120 Lbs \$383.00
155LRVPSM 55 Gal surface mount 120 Lbs \$383.00



Galvanized Dome
DLG55
23 3/4" ID,
12 Lbs \$166.00



Steel 8" Hole
FLS8-55
33Lbs \$122.00



Steel 16" Hole
FLS16-55
28Lbs \$122.00

Dome lids fit on inside of 155 Receptacle
Flat lids fit on outside of 155 Receptacle

WARNING:
Cancer and
Reproductive Harm
www.P65Warnings.com

Quality Thick Vinyl Plastisol:



Than Thermoplastic Square Litter Receptacles with Rain Cover Top

PVC coated metal in many colors. Shipped knocked down to reduce freight. Assembly required. Unit comes with arched rain cover top. Liners included. Choose from these two distinct styles - Laser cut, or Expanded Metal.

*Keep Area Clean With
Commercial Grade
Receptacles!*

Laser Cut

S32LRLC 32 G sq laser cut 150 Lbs \$709.00
S32LRLCSM 32 G surface mount 150 Lbs \$709.00

Expanded Metal

S32LRVPC 32 G sq Expanded 150 Lbs \$635.00
S32LRVPCSM 32 G surface mount 150 Lbs \$635.00



Pewter



Bronze



Black



Classico Smoker's Outpost

Perfect for entrances, designated smoking areas and more! Save on Maintenance with no messy sand or continual clean up. The steel pail liner safely collects cigarette waste and makes cleaning easy and convenient. Patented oxygen-restricting design extinguishes cigarettes quickly - no sand or water needed. 40" height encourages use and makes disposing cigarette waste easy and convenient. Durable all-steel construction is fire-safe, won't melt or burn. The textured powder-coated finish, won't rust or discolor pavement. Airtight screw closure attaches base to lid; base-to-lid security chain included to deter theft. Pre-drilled hole in base for bolt-down hardware. Keyhole cigarette opening discourages unwanted litter. Select Color: Bronze, black or pewter.

CSO 40"H x 15"D 15 Lbs **\$ 308.00**

Upscale!
Attractive appearance and steel construction enhances your image by keeping cigarette butts out of sight and hidden from public view.



Safe Smoker

Cigarette receptacle is made of high density polyethylene with UV inhibitors and a flame retardant additive. The tubular top design restricts oxygen to extinguish burning butts. It keeps rain out and odors in. Top is easily removed to empty the internal 4 gallon galvanized collection bucket. Sand can be added to give weight, or use the integrated hold down tabs to bolt it down. Aesthetic appeal for indoor or outdoor use.

Select color: Beige, black, blue, brown, gray, and green.

SSCR 17 1/2" dia. x 43" high 11 Lbs **\$ 85.00**



Smoker's Butler

Add neatness and a look of class to you facility, indoors or at the entrance. The industrial poly material has the look of beautiful granite. The 9" diameter 25" high snuffer holds 3,000 butts. When full, simply twist the lid off and empty. No messy buckets.

SBCR 9" dia. x 25" high 21 Lbs **\$ 113.00**

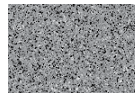

Gray Granite



Tan Granite

**Holds Up to
3,000 Cigarette Butts!**

Estate Flag Pole - External Halyard

External halyard system utilizes the traditional method of raising and lowering the flag which is visible from the outside and is secured in place by wrapping around a cleat fastened to the shaft at 5 feet above grade. Estate flagpoles are ideal for home or small business locations.

- One Halyard
- Revolving single sheave truck assembly
- Gold anodized Aluminum Ball Top
- Chrome Snaps Hooks Necessary to Fly one Flag
- Heavy duty (PVC) ground socket and installation instructions

Model	Height Above Ground	Overall Shaft Length	Butt Dia.	Wall Thickness	Ball Dia.	# Of Sections	Wt.	Max Recommended Flag Size	Pole W/O Flag
KPE15	15 ft.	17 ft.	3"	.125"	3"	1	40	3x5 ft.	\$ 527.00
KPE20	20 ft.	22 ft.	3"	.125"	3"	1	50	4x6 ft.	\$ 622.00
KPE25	25 ft.	27.5 ft.	3"	.125"	3"	1	60	5x8 ft.	\$ 724.00

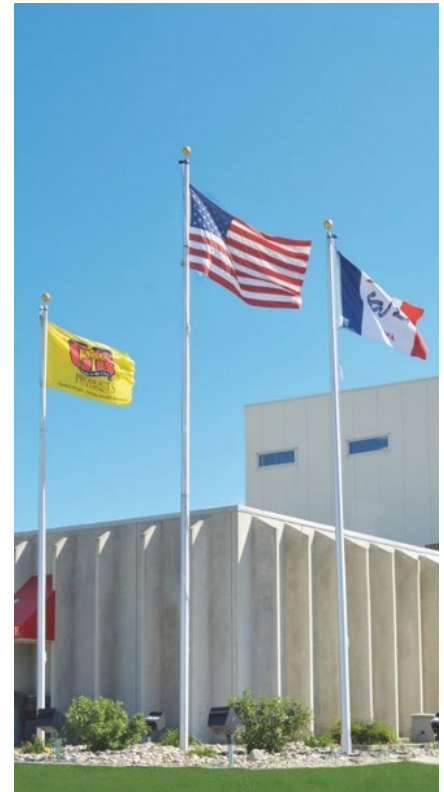

Continental Flag Pole - External Halyard

External halyard system utilizes the traditional method of raising and lowering the flag which is visible from the outside and is secured in place by wrapping around a cleat fastened to the shaft at 5 feet above grade. Continental flagpoles utilizes seamless 6063-T6 aluminum tubing. Designed to be architecturally pleasing.

- One Halyard
- Revolving single sheave truck assembly
- Gold anodized Aluminum Ball Top
- Chrome Snaps Hooks Necessary to Fly one Flag
- Galvanized Steel Ground Socket and installation instructions

Model	Height Above Ground	Overall Shaft Length	Butt Dia.	Wall Thickness	Ball Dia.	# Of Sections	Wt.	Max Recommended Flag Size	Pole W/O Flag
KPC20	20 ft.	23 ft.	4"	.125"	4"	1	90	4x6 ft.	\$ 899.00
KPC25	25 ft.	27 ft.	4"	.125"	4"	1	120	5x8 ft.	\$ 999.00
KPC30	30 ft.	33 ft.	5"	.125"	5"	2	140	6x10 ft.	\$ 1,569.00



Sentry Flag Pole - Internal Halyard

Internal halyard systems differ from the normal external system in that the flag is raised inside the shaft of the flagpole. This is a great security system and protects the flag from unwanted tampering. Sentry flagpoles come with internally mounted "cam-action" cleat system inside a heavily reinforced access door frame assembly.

- One Halyard
- Revolving single sheave truck assembly
- Gold anodized Aluminum Ball Top
- Chrome Snaps
- Counterweight
- Retainer Ring Necessary to Fly one Flag
- Aluminum Flash Collar

Model	Height Above Ground	Overall Shaft Length	Butt Dia.	Wall Thickness	Ball Dia.	# Of Sections	Wt.	Max Recommended Flag Size	Pole W/O Flag
KPS20	20 ft.	23 ft.	5"	.125"	5"	1	120	4x6 ft.	\$ 1,579.00
KPS25	25 ft.	27 ft.	5"	.125"	5"	1	130	5x8 ft.	\$ 1,699.00
KPS30	30 ft.	33 ft.	5"	.125"	5"	2	150	6x10 ft.	\$ 1,569.00



American Flag

Reinforced Polyester Flags

Our flags are made with a heavy grade 2-ply 100% polyester fabric. These flags were developed for people looking for strength and wearing qualities. Ideal for flags flown daily in high wind areas.

Model	Size	Weight	Price
KPFLAG35	3x5 ft.	1	\$ 49.00
KPFLAG46	4x6 ft.	1	\$ 64.00
KPFLAG58	5x8 ft.	2	\$ 99.00
KPFLAG59	5x9.5 ft.	3	\$ 119.00
KPFLAG610	6x10 ft.	4	\$ 139.00



"Custom Flags Available - Please Inquire"

Kay Park Pong Table, Bag Toss & Ladder Toss



Kay Park Pong Table

- Outdoor concrete ping pong
- Fiber reinforced concrete
- Weather proof
- Virtually maintenance free
- Customizable metal net
- Heavy-duty steel frame
- Powdered coat black frame

KPPT 9'L x 30"H x 5'W Table 1,100 Lbs \$ 3,994.00
Customize Net 5'L x 6'H

Table Top Color Options:

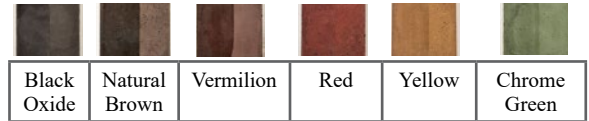

Variations in color due to hand staining process.

**Revenue Generating
Outdoor Concrete
Ping Pong Table**

**Shown in
Chrome Green Top
Standard Powder Coated Black Legs**

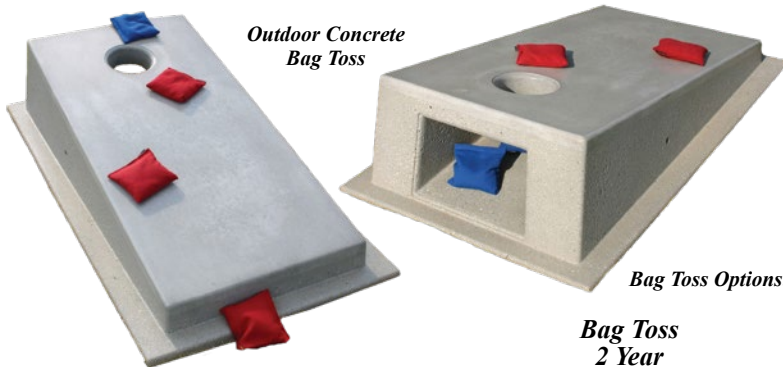

**Outdoor Concrete
Bag Toss**

Bag Toss Options:

**Bag Toss
2 Year
Warranty**

Bags Sold Separately

Custom Bag Toss Colors
and Printing
Please inquire for cost.

Kay Park Bag Toss

All concrete construction with a smooth playing surface. Set up multiples for a great addition to park or outdoor recreation area for family outings or tournaments! **Available in gray finish only.** Add throwers blocks or bike and skate deterrents to finish the bag toss setting.

KPBT Bag Toss (Set 2) 1330 Lbs \$ 1,048.00
KPBTB Throwers Blocks (Set2) 1040 Lbs \$ 387.00
KPBTBD Bike Deterrent 212 Lbs \$ 144.00
KPBTSD Skate Deterrent 8 Lbs \$ 114.00
KPBTB Bags (Set 8) 7 Lbs \$ 41.00

Throwers Blocks



Bike Deterrent



Skate Deterrent



New!



Perfect For:

- Parks
- Resorts
- Camps
- College Campuses
- Military Bases
- Playground
- Campground
- Backyards
- Apartment Complexes

Kay Park Concrete Ladder Toss

- Outdoor concrete Ladder Toss
- Heavy duty reinforced concrete
- Weather proof
- Virtually maintenance free
- Graphite Color finish
- Powder coated solid steel rungs
- Powder coating colors Black or Red, White and Blue

KPCLTC Color Rungs Concrete Toss 42"H x 32"W 280 Lbs \$ 876.00
KPCLTB Black Rungs Concrete Toss 42"H x 32"W 280 Lbs \$ 856.00
KPSLT Steel Ladder Toss 42"H x 32"W 160 Lbs \$ 1,332.00
KPCSB Ladder Support Base 42"H x 42"W x 3H" 425 Lbs \$ 262.00
KPCLTB Throwers Base 42"H x 42"W x 3H" 425 Lbs \$ 262.00
KPLTB Bolas 2 Lbs \$ 56.00

Kay Park Steel Ladder Toss

- I beam steel supports
- Powder coated twice extra protection
- Powder coated solid steel rungs
- Black Color finish
- Powder coated solid steel rungs

Throwers Base



Ladder Support Base



2020

Concrete Ball Bollards

Concrete ball bollards are available in different sport balls for schools and sport facilities.

CBBB36	Baseball	36" W x 36"H	2,000 Lbs	\$ 967.00
CBFB21	Football	21" W x 42"H	700 Lbs	\$ 775.00
CBKT18	Basketball	36" W x 36"H	2,000 Lbs	\$ 967.00
CBSCR36	Soccerball	36" W x 36"H	2,000 Lbs	\$ 967.00



Concrete Sphere Bollard

Sphere bollard comes in two sizes with a square base, very aesthetic.

CBSPH36	39"W x 39" L x 42"H	3,950 Lbs	\$ 1,034.00
CBSPH36	52"W x 52" L x 51"H	6,560 Lbs	\$ 1,925.00

	Smooth	Light Sand Blast	Perma Stone	Dura Brite
Dove Gray				
Terra Cotta				
Light Brown				
Sand Tan				

Select Texture:

*Smooth,
Light Sand Blast,
Permastone
or
Durabrite*

Select Color:

*Dove Gray,
Terra Cotta,
Light Brown
or
Sand Tan*



Concrete Elliptical Cylinder Bollard

CBEB36	16"W x 16"L x 36"H	440 Lbs	\$ 466.00
---------------	--------------------	---------	------------------

Steel reinforced bollard is great for boosting security. Deterrent for vehicle traffic, and marking for pedestrian walking paths. Choose color/ texture.



Mounting Options:

Option A:

Bollard is precast with hollow core. Dimensions of this core are predetermined by the contractor, and need to be specified when placing the order. Existing pad, slab or sidewalk is cast with exposed vertical tubing or pipe to fit inside the core of the bollard. Before bollard is set on exposed tube. On the existing pad, epoxy, caulk, or other bonding agent is applied to core and/or vertical pipe for securing purposes. The bollard is then set in place.

Option B:

Bollard is precast with pipe or tube protruding from bottom of bollard. Dimensions of protruding pipe or tube are pre-determined by the contractor, and need to be specified when placing order. Existing pad, slab, or sidewalk is cast with sleeve correlating to protruding pipe on the bottom of the bollard. Before bollard is set, epoxy, caulk, or other bonding agent is applied to either the tube or the pipe, and/or applied to the sleeves in the existing pad. The bollard is then set in place.

Option C:

Bollard is precast with a pre-determined number and pattern of inserts into the bottom of the bollard. Size and pattern of inserts are determined by the contractor and need to be specified when placing the order. The existing pad, slab or sidewalk is cast with sleeves correlating to the inserts in the bottom of the bollard. Threaded rod (included with purchase of bollard) are then screwed into the inserts in the bottom of the bollard. Epoxy, caulk, or bonding agent is applied to the rod and/or into the sleeves in the existing pad, and the bollard is set into place..



Concrete Receptacles



CTCR30MD

Has a brown plastic dome lid with self-closing door - more lids available. Shown as Sand Tan Durabrite.

CTCR30MD	24" dia x 43"	Lbs	420	\$ 649.00
CTCR30PL	30 Gal. liner	12		\$ 69.00



CTCS22PB & CTCS40PB

Holds a liner up to 22 gal. At 40" h (to top of dome) x 20 1/2" square & has a rigid plastic bonnet top with a self-closing door. Shown in Sand Tan Durabrite.

Larger, 40 gallon size model also available.

CTCS22PB	22 Gal. unit	Lbs	400	\$ 519.00
CTC20PL	20 Gal. liner	11		\$ 68.00
CTCS40PB	40 Gal. unit	740		\$ 671.00
CTC36PL	36 Gal. liner	13		\$ 81.00



CTCR30PH

Has a dark brown rigid plastic hood top open on two sides. Shown in Sand Tan Durabrite.

CTCR30PH	26 1/4" dia x 44"	Lbs	700	\$ 684.00
CTCR30PL	30 Gal. liner	12		\$ 69.00



CTCR30AR

Has a concave pitch in top. Shown in Light Brown Permastone.

CTCR30AR	24" dia x 33"	Lbs	640	\$ 702.00
CTCR30PL	30 Gal. liner	11		\$ 69.00



CTCR22FP/30FP

Two pieces fit together with brown fiberglass pitch in top.

CTCR22FP	21" dia x 33"	Lbs	300	\$ 520.00
CTCR20PL	20 Gal. liner	11		\$ 69.00
CTCR30FP	31" dia x 33"	870		\$ 703.00
CTCR30PL	30 Gal. liner	12		\$ 69.00



CTCR30AP

Has a convex spun aluminum pitch in top. Shown here in Sand Tan Permastone.

CTCR30AP	24" dia x 33"	Lbs	420	\$ 624.00
CTCR30PL	30 Gal. liner	12		\$ 69.00



Popular Square

Features a brown pitch in top and is available in 2 sizes: 22 gal unit is 36" high x 22" square, 30 gal, unit is 30" high x 26" wide x 29" long. Shown in Sand Tan Permastone. (22 gal top is plastic, 30 gal top is fiberglass.)

CTCS22FP	22 Gal. unit	Lbs	620	\$ 613.00
CTC20PL	20 Gal. liner	11		\$ 69.00
CTCS30FP	30 Gal. unit	870		\$ 702.00
CTC30PL	30 Gal. liner	12		\$ 81.00

	Smooth	Light Sand Blast	Perma Stone	Dura Brite
Dove Gray				
Terra Cotta				
Light Brown				
Sand Tan				

Select Texture:

Smooth,
Light Sand Blast,
Permastone
or
Durabrite

Select Color:

Dove Gray,
Terra Cotta,
Light Brown
or
Sand Tan



Round Concrete Table

A modern design with four surrounding seats offers great aesthetics and practicality for patios, food service, etc. It's heavily reinforced concrete construction is very durable. Comes with smooth top and seat surfaces, as well as smooth legs. Available in Sand Tan, Dove Gray, Light Brown, and Terra Cotta. Dedication plaques and logos also available, please inquire. Shown in Dove Gray

CTR4S	Round 66" L x 30" H x 68" W	1040 Lbs	\$ 1,068.00
CTR3H	ADA	900 Lbs	\$ 1,054.00
UMBRKT	Umbrella bracket option		\$ 61.00

Square Concrete Table

Perfect for dressing up a patio or courtyard. Made of strong steel reinforced concrete. Top and seats have protective sealer to assure years of service. Two and four seat models available. Ask about umbrella attachment option. Choose a combination of color and texture to best suit your decor. Photo shows Sand Tan tops and seats with Sand Tan PermaStone legs.



CTS4S	4 seat sq 67 1/2" L x 29" H x 67 1/2" W	1,040 Lbs	\$ 1,068.00
CTS2S	2 seat sq 30" L x 29" H x 66" W	640 Lbs	\$ 946.00
UMBKT	Umbrella bracket option		\$ 24.00

CTR Rectangle Table

"The good old standby." These tables have a combination of beautiful exposed aggregate legs and smooth colored tops and seats to enhance surroundings with a look of natural beauty. You choose the texture and color to best match your decor. SMOOTH CONCRETE tops and seats with color all the way through come in 60" and 84" lengths. A handicap model is also available with the top extended at one end. Shown with Light Brown top and seats and Light Brown Durabrite Legs.



CTRJ60C	Standard 60" L x 29" H x 62" W	1,040 Lbs	\$ 957.00
CTRJ84C	Standard 84" L x 29" H x 62" W	1,128 Lbs	\$ 1,069.00
CTRJ84H	Handicap 84" L x 29" H x 62" W	1,028 Lbs	\$ 1,112.00

Concrete Oval Top Tables

A contemporary look along with a walk through design perfect for almost any setting. Shown with Sand Tan Light Sandblast legs and smooth top and seats. Choose any color for your tables from the selection. Two sizes available. Handicap unit has one end extended to allow for wheelchair.



CTOV72	72" L x 30"H x 60"W oval table	1,400 Lbs	\$ 1,197.00
CTOV84	84" L x 30"H x 60"W oval table	1,600 Lbs	\$ 1,279.00
CTOV84H	84" L x 30"H x 60"W oval table	1,600 Lbs	\$ 1,364.00

Game Board Option

Permanent insert for concrete table tops. Provide the fun!

GBI	\$162.00
------------	-----------------



Concrete Benches



CPB Bench

CPB Series concrete park benches are the most popular because they are a style suitable for almost any decor- and reasonably priced! The seats and back are: 2" thick smooth concrete. Benches come in 58", 72" and 84" lengths. Shown with Gray seats and sand tan permastone legs. All available textures and colors shown on page 39. Plaques sold separately see page 44.

CPB58C	33" H x 58" L concrete	420 Lbs	\$ 579.00
CPB72C	33" H x 72" L concrete	465 Lbs	\$ 614.00
CPB84C	33" H x 84" L concrete	485 Lbs	\$ 649.00



'X' Leg Bench

A unique look for a standard park bench. Heavy, reinforced concrete provides years of trouble-free service. Seat and back are 60" long, so it holds three comfortably. Available in smooth only. Shown in Light Brown.

CPB60X	34" H x 60" L x 24" W	500 Lbs	\$ 610.00
---------------	-----------------------	---------	------------------



CCB72CL

Contoured seat and contoured legs are cast in one piece, 72" long. Available with smooth finish seat and legs, or can be a combination of smooth seat and exposed aggregate legs of your choice. Shown in Light Brown.

CCB72CL	Concrete 18" H x 72" L	500 Lbs	\$ 505.00
----------------	------------------------	---------	------------------



CTB58C

Practical bench has three seat lengths, 58" as shown, 72" and 84" long units that can be used along sides of tables or as stand alone benches. Easy bolt-together assembly! A good value! Shown in Sand Tan seat with Durabrite Gray Legs.

CTB58C	18 1/2" H x 58" L	235 Lbs	\$ 337.00
CTB72C	18 1/2" H x 72" L	210 Lbs	\$ 406.00
CTB84C	18 1/2" H x 84" L	230 Lbs	\$ 418.00



Lattice Bench

Modern art design with long lasting durability of steel reinforced concrete. Shown in Dove gray smooth.

CLB-82	24" x 86" Seat	965 Lbs	\$ 875.00
---------------	----------------	---------	------------------

Handicap Accessible Fountain

A beautiful exposed aggregate finish offers a great natural look for any outdoor setting. This model has plenty of knee clearance for persons in wheelchairs and an easy front push button. Choose optional features to best suit your needs, such as concrete or chrome bowl, side facet, freeze proof valve, or tamper-resistance concrete bubbler guard for your drinking fountain. Comes with drain tile piece and bubbler valve for attaching your plumbing connection. Access panel provides ease of installation and heavy concrete construction offers you peace of mind. Pictured at right is **CHFFBS** shown in Durabrite finish, with a chrome bowl and optional side faucet.

CHFFBS	Standard, chrome bowl	400 Lbs	\$ 1,640.00
CHFFBC	Standard, concrete bowl	410 Lbs	\$ 1,437.00
CHFFBCT	Tamper guard, concrete bowl	420 Lbs	\$ 1,482.00
CHFFBSF	Freeze proof, chrome bowl	400 Lbs	\$ 3,467.00
CHFFBSTF	Tamper & freeze proof, chrome bowl	410 Lbs	\$ 3,303.00
CDFOF	Optional Side facet	10 Lbs	\$ 98.00



Upright Cylinder

Worry-free near outdoor sports fields, hiking trails, etc. Choose concrete color and texture you prefer. Comes in various model features. Optional concrete child step can be purchased so youngsters can get up to drink from bubbler. Model shown is **CDF-PBC** with a PermaStone aggregate finish. Dove gray color, concrete bowl, and push button on the bubbler. Each fountain 220 lbs. Child step 105 pounds.

CDFPBC	Concrete, push button	220 Lbs	\$ 826.00
CDFIBC	Concrete, 1 side button	220 Lbs	\$ 969.00
CDFIBCF	Concrete, push button & freeze	220 Lbs	\$ 2,373.00
CDFFBBS	Chrome, front push button	220 Lbs	\$ 1,190.00
CDFOF	Optional side faucet	220 Lbs	\$ 98.00
CDFOCS	Optional concrete child step	105 Lbs	\$ 182.00

	Smooth	Light Sand Blast	Perma Stone	Dura Brite
Dove Gray				
Terra Cotta				
Light Brown				
Sand Tan				

Select Color:
Dove Gray, Terra Cotta,
Light Brown or Sand Tan

Select Texture:
Smooth, Light Sand Blast,
PermaStone or Durabrite



Ever Popular Round Planters

An elegant look in a variety of sizes. All models have drain holes. Specify color and texture choice.

CPR2417	24" dia. x 17" H	300 Lbs	\$ 340.00
CPR2424	24" dia. x 24" H	350 Lbs	\$ 379.00
CPR2433	24" dia. x 33" H	420 Lbs	\$ 417.00
CPR3017	30" dia. x 17" H	500 Lbs	\$ 450.00
CPR3030	30" dia. x 30" H	800 Lbs	\$ 543.00
CPR3624	36" dia. x 24" H	800 Lbs	\$ 595.00
CPR3630	36" dia. x 30" H	900 Lbs	\$ 671.00
CPR4817	48" dia. x 17" H	900 Lbs	\$ 711.00
CPR4824	48" dia. x 24" H	1,200 Lbs	\$ 785.00
CPR6036	60" dia. x 36" H	2,100 Lbs	\$ 1,129.00



Aspen Rectangle/Square Planters

An elegant look in a variety of sizes. All models have drain holes. Specify color and texture choice.

CPAS2418	24" H x 24" L x 18" W	450 Lbs	\$ 410.00
CPAS2436	24" H x 36" L x 18" W	530 Lbs	\$ 444.00
CPAS2448	24" H x 48" L x 30" W	1,200 Lbs	\$ 879.00
CPAS3648	36" H x 48" L x 36" W	1,700 Lbs	\$ 1,116.00
CPAS4848	48" H x 48" L x 36" W	2,500 Lbs	\$ 1,177.00
CPAS3660	36" H x 60" L x 36" W	2,700 Lbs	\$ 1,186.00
CPAS3672	36" H x 72" L x 36" W	3,100 Lbs	\$ 1,323.00
CPAS1660	16" H x 60" L x 18" W	650 Lbs	\$ 708.00
CPAS2472	24" H x 72" L x 18" W	935 Lbs	\$ 752.00



Fountains

Our commercial steel drinking fountains come in many configurations. Choose from pedestal type or wall mounted drinking fountains, or ADA drinking fountains for public buildings, or shower towers and foot washing stations for public beaches. We also offer pet drinking fountains, which are popular for dog parks and walking trails. Heavy Steel Drinking Fountains shown can withstand rough conditions, and have a powder coat finish. Specify color when ordering.



Wall Mounted Fountain

It has a chrome-plated brass bubbler locked to a stainless steel receptor, a push button valve and a clear coat protective finish over the powder coat.

KP53SWF Standard 70 Lbs \$ 1,585.00
KP53SWFFP Freeze proof 90 Lbs \$ 2,198.00



Triple Height

Perfect for high traffic areas.

KP59THF Standard 190 Lbs \$ 3,699.00
KP59THFFP Freeze proof 250 Lbs \$ 5,272.00



Bottle Filler

Bottle Filler with ADA Drinking Fountain

Water bottle filler is great for any location.

KP77BFDF Standard 180 Lbs \$ 3,927.00

Black
Dark Bronze
Tan
Blue
Green
Red
Orange
Yellow
Silver
White



Pet Fountain

Slow draining pet fountain, great for dog parks.

KP90PF Standard 85 Lbs \$ 1,683.00
KP90PFFP Freeze proof 115 Lbs \$ 2,558.00

Outdoor Shower + Footwash

Excellent for beach sides.

KP62BFS Standard 210 Lbs \$ 1,872.00

- Brushed aluminum gravity type filler spout
- Vandal resistant interlock chrome plated brass drain
- Replaceable in line water filter
- Push button valve



Dual-Height

Meets multiple needs.

KP57SDF	Standard	155 Lbs	\$ 2,775.00
KP57SDFFP	Freeze proof	185 Lbs	\$ 4,156.00



Cylindrical

Popular choice for years.

KP25SPF	Standard	120 Lbs	\$ 2,054.00
KP25SPFFP	Freeze proof	150 Lbs	\$ 2,919.00

Made of Powder Coated Heavy-Duty Steel

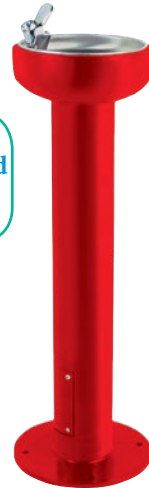

Economical

Offers low cost durability.

KP44SEF	Standard	45 Lbs	\$ 1,047.00
----------------	----------	--------	-------------

Standard Features:

- Steel Guard over a chrome-plated brass bubbler
- Chrome-plated push-button brass valve
- Adjustable flow regulation
- Stainless Steel Bowl



Cylinder + Pet

Perfect near walking trails.

KP53SWPF	Standard	140 Lbs	\$ 2,804.00
KP53SWPFFP	Freeze proof	170 Lbs	\$ 4,162.00



ADA Fountain

Domed cylinder type.

KP545H	Standard	145 Lbs	\$ 2,338.00
KP545HFP	Freeze proof	175 Lbs	\$ 3,398.00



Wheelchair Accessible

A contemporary design.

KP47SHF	Standard	80 Lbs	\$ 2,263.00
KP47SHFFP	Freeze proof	100 Lbs	\$ 3,171.00

Side hose bibs, pet bowls, and other features optional!

Please Inquire!
1-800-553-2476

Courtyard Furnishings



Shown: JPCTB4 Cedar

Courtyard Bench

High quality recycled plastic with an upscale steel design for making your area people friendly! Made with four or eight 2"x4" Resinwood slats and a silver powder-coated frame. Standard stainless steel hardware. Mounting hardware included.

JPCTB4	4' 2 Back Supports	160 Lbs	\$ 1,120.00
JPCTB6	6' 3 Back Supports	195 Lbs	\$ 1,344.00



Shown: JPCTB6 Green

Color Options:



High Quality Recycled Plastic



Shown: JPCTBL6 Redwood

Courtyard Backless Bench

Made with four or eight 2"x4" Resinwood slats and a silver powder-coated frame. Standard stainless steel hardware. Mounting hardware included.

JPCTBL6	6' 3 Back Supports	100 Lbs	\$ 840.00
----------------	--------------------	---------	------------------

Courtyard Receptacle

Heavy duty steel, silver powder coated frame with twenty 1" x 4" Resinwood slats. Stainless steel hardware is standard. Surface mounting kit included.

JPCTLR32 32 Gal. Receptacle 140 Lbs \$ 1,232.00

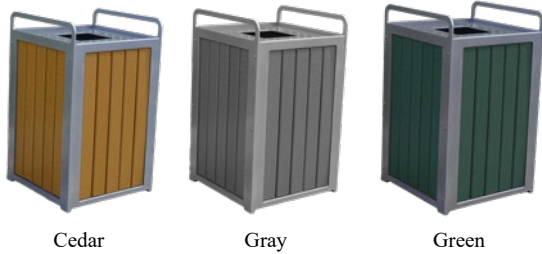

Cedar

Gray

Green

- Parks
- Gardens
- Ski towns
- Resorts
- High Traffic Area



Shown: JPCTLR32 Redwood

Upscale Steel Design

Courtyard Table

2" x 4" and 2" x 6" Resinwood slats and elegant silver powder-coated frame. Standard stainless steel hardware. Pair with the courtyard chair and make your area people friendly!

JPCTT42 42" Casual Table 155 Lbs \$ 1,008.00

Courtyard Chair

2" x 4" and 1" x 4" Resinwood slats and elegant silver powder-coated frame. Comes with mounting stainless steel hardware.

JPCTC24 24" Seat height 105 Lbs \$ 896.00



Shown: JPCTT42Gray



Shown: JPCTC24 Cedar



Shown: JPCTC24 Redwood

Shown: JPCTT42 Redwood

Chair and Table Sold Separately.

Plaques



Cast Aluminum

Cast Aluminum

ALMPLQ Cast Aluminum - Forever 4"H x 6" L 2 Lbs \$136.00

Cast Bronze

Cast Bronze

BRZPLQ Cast Bronze - Forever 4"H x 6" L 2 Lbs \$225.00



Black Plastic w/Gold Lettering

Black Plastic w/Gold Lettering

PLAQUE40-B Black w/ Gold Lettering 2-3" H x 4-6" L 1 Lbs \$40.00



Gold Plastic w/Black Lettering

Gold Plastic w/Black Lettering

PLAQUE40-G Gold w/Black Lettering 2-3" H x 4-6" L 1 Lbs \$40.00

Personalize
It!



Engraving Only on Recycled Plastic

Engraving Options:

PLASTICENGRAVE8	Engraving 8' Plank	48 Characters	\$72.00
PLASTICENGRAVE6	Engraving 6' Plank	38 Characters	\$72.00
PLASTICENGRAVE4	Engraving 4' Plank	28 Characters	\$72.00

Ornate Cast Aluminum Benches

Add "ageless" elegance to any area with these cast aluminum benches. Cast aluminum frame has electrostatic powder finish. The aluminum frames will never rust and can never leave rusty marks on your floor. Pre-finished White Oak slats, 2 1/2" x 3/4", with rounded edges add beauty to these well-chosen benches. Also available in maintenance-free recycled plastic Hi-wood slats. Perfect for interior or exterior use. Feet can be drilled for stationary mounting. Add 'SM' to the model number and add \$20.00 to the price. Benches are available in 48", 60", or 80" lengths. For extra strength, 60" and 80" benches have a third leg in the center with the armrest removed.



Victorian Bench

VBS48	48" Standard oak bench 2 legs	47 Lbs	\$ 416.00
VBS48RP	48" Bench w/recycled slats	70 Lbs	\$ 628.00
VBP60	60" Plantation oak bench	73 Lbs	\$ 523.00
VBP60RP	60" Bench w/recycled slats	109 Lbs	\$ 697.00
VBLF80	80" Longfellow oak bench 3 legs	88 Lbs	\$ 562.00
VBLF80RP	80" Bench w/recycled slats	132 Lbs	\$ 898.00

Renaissance Bench

RBS48	48" Standard oak bench 2 legs	60 Lbs	\$ 469.00
RBS48RP	48" Bench w/recycled slats	90 Lbs	\$ 709.00
RBP60	60" Plantation oak bench	80 Lbs	\$ 583.00
RBP60RP	60" Bench w/recycled slats	120 Lbs	\$ 784.00
RBLF80	80" Longfellow oak bench 3 legs	100 Lbs	\$ 629.00
RBLF80RP	80" Bench w/recycled slats	150 Lbs	\$ 1,023.00



*Rust FREE
Aluminum Frames*



Woodland Bench

WBS48	48" Standard oak bench 2 legs	75 Lbs	\$ 459.00
WBS48RP	48" Bench w/recycled slats	112 Lbs	\$ 692.00
WBP60	60" Plantation oak bench	90 Lbs	\$ 575.00
WBP60RP	60" Bench w/recycled slats	135 Lbs	\$ 758.00
WBLF80	80" Longfellow oak bench 3 legs	100 Lbs	\$ 621.00
WBLF80RP	80" Bench w/recycled slats	149 Lbs	\$ 989.00



Frame Colors:

Brown
Green
Black
White

Recycled Colors:

Redwood Cedar

Backless Renaissance

RBBS48	48" Standard oak bench 2 legs	45 Lbs	\$ 347.00
RBBS48RP	48" Bench w/recycled slats	56 Lbs	\$ 523.00
RBBP60	60" Plantation oak bench	60 Lbs	\$ 438.00
RBBP60RP	60" Bench w/recycled slats	75 Lbs	\$ 562.00
RBBLF80	80" Longfellow oak bench 3 legs	70 Lbs	\$ 465.00
RBBLF80RP	80" Bench w/recycled slats	88 Lbs	\$ 688.00



Windsor Select Site Amenities



Windsor Select

Is a line of fine quality site amenities for indoor or outdoor use. The recycled plastic slats are 2" x 3" to create a finer, more elegant look. Slats are attached from the back side using stainless steel fasteners. Recycled plastic is UV protected and will maintain its good appearance for many years with little or no maintenance. Colors are Gray, Cedar, Brown, or Redwood. Please specify when ordering. Recycled plastic is steel reinforced where needed to avoid sagging. All frames are powder coated black.

Windsor Lumbar Comfort Bench

WS4LCBRP	4' Lumbar bench	189 Lbs	\$ 582.00
WS6LCBRP	6' Lumbar bench	213 Lbs	\$ 767.00
WS4LCBRPIG	4' In Ground Lumbar	199 Lbs	\$ 612.00
WS6LCBRPIG	6' In Ground Lumbar	223 Lbs	\$ 796.00
ARCB	Armrest (set of two)	18 Lbs	\$ 42.00



Recycled Colors:



Cedar Redwood Gray Brown

Windsor Flat Bench

Both the lumbar comfort and flat benches utilize 2"x3" slats which come in recycled plastic colors of cedar, brown, gray or redwood. The gentle curve of the lumbar comfort feels so good you will almost hear the sighs of relaxation. Plan for comfort along with a pleasing look. Steel frames are powder coated black. Please specify color of recycled plastic when ordering.

WS4FCBRP	4' Flat bench	108 Lbs	\$ 305.00
WS6FCBRP	6' Flat bench	174 Lbs	\$ 414.00
WS4FCBRPIG	4' In Ground Flat bench	118 Lbs	\$ 334.00
WS6FCBRPIG	6' In Ground Flat bench	184 Lbs	\$ 442.00



Great For:

- * *Malls*
- * *Pavilions*
- * *Food Courts*
- * *Courtyards*
- * *City Parks*
- * *Street Projects*
- * *River Walks*
- * *Zoos*
- * *Office*
- * *And Much More!*



Windsor Select Planters

These Windsor Select Planters are 26" diameter and 30", 24", and 18" high. They are also made in round or square shapes. Slats are 2"x3" recycled plastic. Planters are free-standing on a 2" high circular base and have a plate for bolting down to the concrete or can be mounted on an in-ground post. Includes fiberglass liner with drain holes.

Round Windsor Select Planters

WSRP2630RP	Recycled plastic	128 Lbs	\$ 528.00
WSRP2624RP	Recycled plastic	110 Lbs	\$ 464.00
WSRP2618RP	Recycled plastic	92 Lbs	\$ 399.00
3032LRIG	In-ground post	15 Lbs	\$ 36.00

Square Windsor Select Planters

WSSP2630RP	Recycled plastic	185 Lbs	\$ 723.00
WSSP2624RP	Recycled plastic	160 Lbs	\$ 633.00
WSSP2618RP	Recycled plastic	135 Lbs	\$ 542.00
3032LRIG	In-ground post	15 Lbs	\$ 36.00

Windsor Select Square Table

Windsor Select square table with a 48" top and 36" long seats. Frames are powder coated black. Legs are 1 5/8" O.D. schedule 40 pipe. Ground space 6'8" x 6'8".

WS4JCRP 4' Square Table 312 Lbs \$ **1,343.00**



Windsor Select Picnic Table

Windsor Select picnic table top and seats are 6' long. Frames are powder coated black. Legs are 1 5/8" O.D. schedule 40 pipe. Ground space 5' x 6'

WS6JCRP 6' Table 242 Lbs \$ **1,207.00**



Magnificent Modern Design

Windsor Single Post Table

Windsor Select Single Post Table frames are powder coated black, center post is 6" x 6" x 1/4" sq tube, seats support arms are 3 1/2" O.D. pipe. Ground space 6' x 5' (rectangle). 'SM' = Surface Mount. 'IG' = In-Ground.

WS6SPTCRP-SM Single Post 374 Lbs \$ **1,540.00**
WS6SPTCRP-IG Single Post 374 Lbs \$ **1,506.00**

Recycled Colors:



Cedar Redwood Gray Brown



32 Gallon Litter Receptacle

The Windsor Select 32 Gallon Litter Receptacle slats are 2"x3"x30 recycled plastic that are available in gray, cedar, brown, or redwood colors. This receptacle is free-standing on a 2" high circular base, but also has a plate for mounting on a post. Other lids purchased separately.

WS3032LRPP Litter receptacle 128 Lbs \$ **578.00**
3032LRIG In-ground post 15 Lbs \$ **36.00**

Plastic Dome Colors:



DLMP32-55
 24" ID, 10 Lbs
 \$99.00



Galvanized Dome
DLG55
 23 3/4" ID, 12 Lbs
 \$166.00



Steel 8" Hole
FLS8-32
 13 Lbs
 \$115.00



Steel 16" Hole
FLS16-32
 11 Lbs
 \$115.00



Galvanized Lid
CG32LID
 3 Lbs
 \$11.00



Galvanized Can
CG32
 13 Lbs
 \$69.00



Plastic Liner
CP32
 11 Lbs
 \$36.00



Park Benches

Premium
Recycled
Plastic



6CB4RPIG
4x4's Shown

In Ground Contour Bench

Designed for indoor or outdoor use. The contoured supports are 3/8" x 4" rolled steel that is formed to shape a smooth comfortable seat and backrest. The steel leg consists of 2 1/2" square support tube welded to an arched 3/8" x 4" formed steel base. The entire frame is coated black for long life and good appearance. This frame is specifically designed so it can be fitted with 2" x 4", 3"x 4", or 4" x 4" slats of your choice, pressure treated No. 1 Southern Yellow Pine, or Recycled Plastic slats. In Ground mount.

CB2IG	Frame only, In ground mount	80 Lbs	\$ 200.00
6CB2SYP	6' Frame w/SYP 2x4s	170 Lbs	\$ 352.00
8CB2SYP	8' Frame w/SYP 2x4s	196 Lbs	\$ 397.00
4CB3RPIG	4' Frame w/rec plastic 3x4s	178 Lbs	\$ 579.00
6CB3RPIG	6' Frame w/rec plastic 3x4s	234 Lbs	\$ 715.00
8CB3RPIG	8' Frame w/rec plastic 3x4s	348 Lbs	\$ 919.00
4CB4RPIG	4' Frame w/rec plastic 4x4s	288 Lbs	\$ 752.00
6CB4RPIG	6' Frame w/rec plastic 4x4s	354 Lbs	\$ 996.00
8CB4RPIG	8' Frame w/rec plastic 4x4s	440 Lbs	\$ 1,238.00
ARCB24	Set of two armrests 2x4, 3x4, 4x4	18 Lbs	\$ 42.00



6FB3RP
4x4's Shown

Flat Bench

The Flat Bench has a black powder coated frame and three seat material options. Your choice of Southern Yellow Pine 2x4, or Recycled Plastic in 3x4 or 4x4s. The legs are 2 1/2" square steel tube with 3/8" x 4" mounting plates 4', 6' or 8' long.

FB2	Frame only, surface mount	40 Lbs	\$ 141.00
6FB2SYP	6' Frame w/SYP 2x4s	84 Lbs	\$ 171.00
8FB2SYP	8' Frame w/SYP 2x4s	98 Lbs	\$ 178.00
4FB3RP	4' Frame w/rec plastic 3x4s	105 Lbs	\$ 272.00
6FB3RP	6' Frame w/rec plastic 3x4s	135 Lbs	\$ 369.00
8FB3RP	8' Frame w/rec plastic 3x4s	177 Lbs	\$ 499.00
4FB4RP	4' Frame w/rec plastic 4x4s	113 Lbs	\$ 343.00
6FB4RP	6' Frame w/rec plastic 4x4s	155 Lbs	\$ 478.00
8FB4RP	8' Frame w/rec plastic 4x4s	218 Lbs	\$ 651.00

Recycled Plastic Colors:



Cedar Gray Brown



6CB3RP
3x4's Shown

Surface Mount Contour Bench

Designed for indoor or outdoor use. The contoured supports are 3/8" x 4" rolled steel that is formed to shape a smooth comfortable seat and backrest. The steel leg consists of 2 1/2" square support tube welded to an arched 3/8" x 4" formed steel base. The entire frame is coated black for long life and good appearance. This frame is specifically designed so it can be fitted with 2" x 4", 3"x 4", or 4" x 4" slats of your choice, pressure treated No. 1 Southern Yellow Pine, or Recycled Plastic. Comes standard with Surface Mount Legs.

CB2	Frame only, surface mount	70 Lbs	\$ 171.00
6CB2SYP	6' Frame w/SYP 2x4s	160 Lbs	\$ 320.00
8CB2SYP	8' Frame w/SYP 2x4s	186 Lbs	\$ 364.00
4CB3RP	4' Frame w/rec plastic 3x4s	168 Lbs	\$ 497.00
6CB3RP	6' Frame w/rec plastic 3x4s	224 Lbs	\$ 689.00
8CB3RP	8' Frame w/rec plastic 3x4s 3 Legs	330 Lbs	\$ 893.00
4CB4RP	4' Frame w/rec plastic 4x4s	278 Lbs	\$ 721.00
6CB4RP	6' Frame w/rec plastic 4x4s	344 Lbs	\$ 963.00
8CB4RP	8' Frame w/rec plastic 4x4s 3 Legs	430 Lbs	\$ 1,194.00
ARCB24	Set of two armrests 2x4, 3x4, 4x4	18 Lbs	\$ 42.00



Landmark Series Amenities - Recycled Plastic Products



A.



B.

Landmark Series Amenities

Good for the environment! Not only do they save trees, but they also reduce landfill use! Our recycled plastic is colored with a unique UV process that adds an attractive wood grain appearance. It never needs to be sealed, painted, stained and will not rot. It is maintenance-free! It is also vandal-resistant. Pens and markers can be washed off and paint will not bond to the surface - it can be removed with sandpaper or a paint scraper. Scratches to the surface can easily be ironed or sanded away. These products are designed to give years and years of trouble free service, while keeping their nice appearance. Choose color when ordering.



C.

A. 4' Landmark Backless Bench	70 Lbs	JPABL4	\$ 495.00
A. 5' Landmark Backless Bench	80 Lbs	JPABL5	\$ 553.00
A. 6' Landmark Backless Bench	90 Lbs	JPABL6	\$ 571.00
B. 6' Complete Set	310 Lbs	JPAPT6	\$ 1,749.00
C. 4' Landmark Bench 2 Legs	120 Lbs	JPAB4	\$ 717.00
C. 5' Landmark Bench 3 Legs	135 Lbs	JPAB5	\$ 816.00
C. 6' Landmark Bench 3 Legs	155 Lbs	JPAB6	\$ 849.00
D. 32 Gal. Hinged Receptacle	140 Lbs	JPSLR32	\$ 552.00
D. 32 Gal. Liner	6 Lbs	JP32LINER	\$ 56.00
E. 32 Gal Round Receptacle	60 Lbs	JPRLR32	\$ 519.00
E. 32 Gal Liner	6 Lbs	JP32LINER	\$ 56.00
E. 55 Gal Round Receptacle	75 Lbs	JPRLR55	\$ 668.00
E. 55 Gal Liner	11 Lbs	JP55LINER	\$ 107.00
F. 32 Gal Square Receptacle	75 Lbs	JPSPLR32	\$ 742.00
F. 32 Gal Liner	6 Lbs	JP32LINER	\$ 56.00

Recycled Plastic Colors:



Green Cedar Gray



D.



E.



F.

New!

Recycled Plastic Benches



2" x 6"
Slats

2 Slat Bench

JPCB4	4' Bench - 2 legs	105 Lbs	\$ 346.00
JPCB6	6' Bench - 3 legs	160 Lbs	\$ 519.00
JPCB8	8' Bench - 4 legs	210 Lbs	\$ 643.00

JPSMBOLT	Surface Mount	\$ 24.00
JPIGKIT	4 J Bolts	

**100% Maintenance Free
Recycled Plastic!**



2" x 4"
Slats

3 Slat Backless Bench

JPSB42	4' Bench - 2 legs	75 Lbs	\$ 222.00
JPSB63	6' Bench - 3 legs	85 Lbs	\$ 288.00
JPSB83	8' Bench - 4 legs	125 Lbs	\$ 369.00

JPSMBOLT	Surface Mount	\$ 24.00
JPIGKIT	4 J Bolts	



100%
Recycled Plastic

Benches have black frame - choose slat color.



Furniture Colors:



Seaside Adirondack Style Furniture

Seaside Adirondack style furniture made of thick recycled plastic for long life and great appearance.

JPSAC	Chair	\$ 379.00
JPOT	Ottoman	\$ 148.00
JPST	Side Table	\$ 148.00

1" x 4"
Slats



2" x 4"
Slats

3 Slat Bench

JPCB42	4' Bench - 2 legs	130 Lbs	\$ 363.00
JPCB63	6' Bench - 3 legs	185 Lbs	\$ 544.00
JPCB83	8' Bench - 4 legs	205 Lbs	\$ 643.00

JPSMBOLT	Surface Mount	\$ 24.00
JPIGKIT	4 J Bolts	

Recycled Plastic Colors:



Cedar Brown Gray Green

Recycled Plastic Table

JPPT63	6' Table - 3 legs	425 Lbs	\$ 783.00
JPPT83ADA	8' Table - 3 legs	475 Lbs	\$ 891.00
JPPT83	8' Table - 3 legs	480 Lbs	\$ 981.00

JPSMKIT	L - Bracket	\$ 24.00
JPIGKIT	4 J Bolts	

100%
Recycled Plastic



2" x 10"
Planks

Hexagon Table

JPHT	Hexagon table	250 Lbs	\$ 849.00
JPHTADA	Hex - table ADA	210 Lbs	\$ 825.00

JPSMKIT	L - Bracket	\$ 24.00
JPIGKIT	4 J Bolts	



Cedar & Green
Plank Only

6 Foot Table

JPAF6	6' Table	240 Lbs	\$ 839.00
JPAF6ADA	6' Table - ADA	280 Lbs	\$ 995.00

JPSMKIT	L - Bracket	\$ 24.00
JPIGKIT	4 J Bolts	

Recycled Plastic Colors:



Cedar Brown Gray Green



2" x 10"
Planks

Tables have black frame - choose plank color.

100% Recycled Plastic Child Table

Made from 100% post consumer recycled plastic. Maintenance free. Black frame. Specify plank color.

JPAFCS4	4' Child size table	100 Lbs	\$ 478.00
----------------	---------------------	---------	------------------

JPSMKIT	L - Bracket	\$ 24.00
JPIGKIT	4 J Bolts	



Cedar Green Only



Child's Table

Recycled Plastic Products



NEW!

Zig-Zag Message Center

Recycled Plastic message center with six sides with three hinges and shatter resistant doors.

JPMCZZ 6 Sides, 4 Post Hinged 565 Lbs \$ 3,519 .00

Recycled Colors:



100% Recycled Plastic



Cedar Green

*Resin-wood Framework
With Shatter Resistance
Clear Plastic Sheet*



Recycled Plastic Message Center

Our premium quality message centers are made from 100% recycled plastic. Our recycled plastic is maintenance free! It will never rot, rust, chip, splinter or peel. It is graffiti resistant and has UV inhibitors to prevent color fading. Our message centers are made with crystal clear, high-impact acrylic viewing glass that will not yellow. The glass is 100 times stronger than regular glass. We use zinc coated locks to secure the sliding doors. A high quality cork board display surface is included. Great for indoor or outdoor use! Message centers are offered in three sizes: Small = 20" x 3.5" x 26", Medium = 36" x 3.5" x 26", Large = 51" x 3.5" x 36". Medium and large sizes are offered as two different models: single sided or double sided. Each unit can be purchased as wall mount or with reinforced mounting posts. Now with thicker cork board. Available in green or cedar.

Sliding Doors

JPMCS1W	Sm msg ctr, 1 side, wall mnt.	40 Lbs	\$ 247.00
JPMCS1P	Sm msg ctr, 1 side w/post	70 Lbs	\$ 363.00
JPMCM1W	Med msg ctr, 1 side, wall mnt.	60 Lbs	\$ 371.00
JPMCM1P	Med msg ctr, 1 side w/posts	120 Lbs	\$ 610.00
JPMCM2P	Med msg ctr, 2 sides w/posts	150 Lbs	\$ 915.00
JPMCL1W	Lg msg ctr, 1 side, wall mnt.	90 Lbs	\$ 668.00
JPMCL1P	Lg msg ctr, 1 side w/posts	155 Lbs	\$ 915.00
JPMCL2P	Lg msg ctr, 2 sides w/posts	190 Lbs	\$ 1,014.00

Hinged Doors

JPHMCS1W	Sm msg ctr, 1 side wall mnt.	40 Lbs	\$ 363.00
JPHMCS1P	Sm msg ctr, 1 side w/posts	70 Lbs	\$ 478.00
JPHMCM1W	Med msg ctr, 1 side wall mnt	60 Lbs	\$ 481.00
JPHMCM2P	Med msg ctr, 2 side w/posts	150 Lbs	\$ 717.00



Sliding Doors



Hinged Doors

*Top Quality Marine Grade Cork
and Specially
Coated Locking Mechanisms*



Car Stops

Recycled Plastic car stops won't be harmed by snow, sand, salt, or bad drivers. Let gravity hold them in place or pin them with spikes or rebar. Available in grey, blue or yellow.

PRCS6 4" X 6" X 72" 42 Lbs \$ 59.00

Colors:



Solid Top Hex Table

Has a 41" diameter top on standard or ADA version.

PRSHT	Std hex table	354 Lbs	\$ 899.00
PRADAHT	ADA hex table	316 Lbs	\$ 899.00

**Furniture has black frames:
Choose Slat Color**



Rock Island Bench

Has 2" x 6" planks on back and 2"x4" on seat.

PR4RIB	4' Bench	118 Lbs	\$ 346.00
PR6RIB	6' Bench	178 Lbs	\$ 429.00
PR8RIB	8' Bench	237 Lbs	\$ 595.00
PR1ARM	Arm Rest	11 Lbs	\$ 92.00
PRSMKIT			\$ 48.00

Go Green!!!



Hi-Back Bench

This multi-slat bench has a comfortable contour.

PR4HBB	4' Bench	140 Lbs	\$ 384.00
PR5HBB	5' Bench	159 Lbs	\$ 433.00
PR6HBB	6' Bench	172 Lbs	\$ 452.00
PRSMKIT			\$ 48.00



**Available with
in-ground mount legs**



Curved Mesa Bench

Comes in 5ft. lengths and can be placed end-to-end to form an "S" or semi-circle. Great around trees or fire pits! 8 of these benches make a circle.

PR5CMB	5' Curved mesa bench	67 Lbs	\$ 341.00
---------------	----------------------	--------	------------------



**8 Benches makes a
10' Diameter inside
12' Diameter outside**

Plastisol Coated Benches



Curved Rod

Give a modern appearance without sacrificing comfort! Formed, one-piece seat and back units are PVC coated for long life and low maintenance. The legs are 2 3/8" O.D. pipe with black powder coating and feet are drilled for surface mounting. Comes in two sizes.

CRB48VP	48" Bench	120 Lbs	\$ 634.00
CRB72VP	72" Bench	155 Lbs	\$ 763.00



Than Thermoplastic

Laser Cut

Laser cut bench has 2 3/8" O.D. pipe with black powder coating legs with 12 gauge HR steel seat coated in PVC for a beautiful quality finish.

LCB48VP	48" Bench	130 Lbs	\$ 688.00
LCB72VP	72" Bench	170 Lbs	\$ 817.00

*Thicker, Softer Protection
For Long-Lasting Quality!*

Quality Thick Vinyl Plastisol:

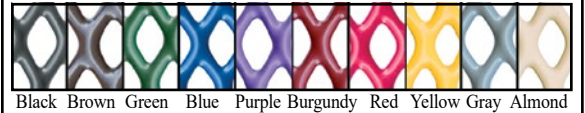

WARNING: Cancer and Reproductive Harm www.P65Warnings.com



Portable Legs Shown

Classic Supreme Flat Bench

The 15" wide flat seat of this classic bench with its rolled edges offers more relaxed comfort. This all PVC bench is an excellent choice for locker rooms and dugouts.

CSF6VPP	6' Portable	75 Lbs	\$ 321.00
CSF8VPP	8' Portable	91 Lbs	\$ 340.00
CSF6VPSM	6' Surface mount	73 Lbs	\$ 270.00
CSF8VPSM	8' Surface mount	89 Lbs	\$ 289.00
CSF6VPIG	6' In-ground	75 Lbs	\$ 276.00
CSF8VPIG	8' In-ground	91 Lbs	\$ 293.00



Surface Mount Legs Shown

Classic Supreme Flat Bench

Classic rounded edges of this portable plastisol coated bench contributes to its nice appearance and comfort. (10" wide seat and back.) (In-ground, portable, and surface mounting available.)

CWB6VPP	6' Portable with back	110 Lbs	\$ 502.00
CWB8VPP	8' Portable with back	130 Lbs	\$ 558.00
CWB6VPSM	6' Surface mt w/ back	106 Lbs	\$ 461.00
CWB8VPSM	8' Surface mt w/ back	126 Lbs	\$ 528.00
CWB6VPIG	6' In-ground w/ back	110 Lbs	\$ 461.00
CWB8VPIG	8' In-ground w/ back	130 Lbs	\$ 528.00

*Coated Frame
Standard*

Expanded Thermoplastic Picnic Table

Picnic table frame is 2 3/8" O.D. in a convenient, walk-through design, and comes with a standard black powder coat finish. The top and seats are fabricated of 9 ga. flattened expanded metal in various lengths. Tops and seats have thermoplastic coating – see color selection below.

MC4EXP	4' Portable table	160 Lbs	\$ 677.00
MC6EXP	6' Portable table	210 Lbs	\$ 708.00
MC8EXP	8' Portable table	280 Lbs	\$ 763.00

*Purchase More Tables
With Less Cost*



46" Round Expanded Thermoplastic Table

Round table frame has black powder coated 2" O.D. steel tubular legs. Top is 46" dia. curved seats surround top. Top and seats are 9 ga. flattened expanded metal with your color choice of thermoplastic coating. Choose from colors below.

MC46RO	46" Round Table	255 Lbs	\$ 806.00
MC46RO3S	46" Round Table 3 Seats	220 Lbs	\$ 763.00

*Popular Circular
Seating!*



46" Octagon Spider Leg Expanded Thermoplastic Table

Octagon table frame has black powder coated 2" O.D. steel tubular spider legs. Top is 46" dia. curved seats surround top. Top and seats are 9 ga. flattened expanded metal with your color choice of thermoplastic coating. Choose from colors below.

MC46OSL	46" Table	302 Lbs	\$ 899.00
MC46OSL3S	46" Round Table 3 Seats	275 Lbs	\$ 969.00



46" Square Expanded Thermoplastic Table

Square table has 46" top and 36" seats of 9 ga. flattened expanded metal that is thermoplastic coated in a variety of colors. Legs are 2" O.D. tubular steel with a standard black powder coated finish. Select top and seat color when ordering.

MC46SQ	46" Sq. Square Table	265 Lbs	\$ 779.00
MC46SQ3S	46" Sq. Table 3 Seats	230 Lbs	\$ 763.00



Expanded Thermoplastic Colors:



Thermoplastic Steel Benches



Perforated Steel with Back

Well suited to outdoor settings. Made with 11 ga steel. Seats and backs are coated in weather-resistant thermoplastic. Tubular legs are 2 3/8" O.D. with a black powder coat finish.

Special Identity Benches

A great way to show school spirit and other public entities and to deter theft. With your personalization laser cut into the backrest. (Included in price.) Up to 21 characters per line. Two line max.



Special Identity Benches	4' Portable with back	159 Lbs
	6' Portable with back	164 Lbs
	8' Portable with back	184 Lbs
	4' Surface mount with back	159 Lbs
	6' Surface mount with back	164 Lbs
	8' Surface mount with back	184 Lbs
	4' In ground with back	159 Lbs
	6' In ground with back	164 Lbs
	8' In ground with back	184 Lbs

Perforated Steel With Back		Special Identity Benches	
PSPB4TPP	\$ 425.00	SIPSPB4TPP	\$ 695.00
PSPB6TPP	\$ 446.00	SIPSPB6TPP	\$ 726.00
PSPB8TPP	\$ 488.00	SIPSPB8TPP	\$ 748.00
PSPB4TPSM	\$ 425.00	SIPSPB4TPSM	\$ 695.00
PSPB6TPSM	\$ 446.00	SIPSPB6TPSM	\$ 726.00
PSPB8TPSM	\$ 488.00	SIPSPB8TPSM	\$ 748.00
PSPB4TPIG	\$ 425.00	SIPSPB4TPIG	\$ 695.00
PSPB6TPIG	\$ 446.00	SIPSPB6TPIG	\$ 726.00
PSPB8TPIG	\$ 488.00	SIPSPB8TPIG	\$ 748.00

Backless Bench Available



Diamond Bench

Cast iron legs with thermoplastic coating for long lasting color and durability. Have the option of the dog park or buddy bench. Laser cut into the backrest dog paws and bones which creates the perfect place to sit for pet owners during those dog park excursions or "Buddy Bench" to promote kindness, inclusion, and friendship with this roll formed bench.



	Diamond Bench	Dog Park Bench	Buddy Bench
4' Portable with back	245 Lbs PSDB4 \$ 806.00	PSDP4 \$ 862.00	PSBB4 \$ 862.00
5' Portable with back	255 Lbs PSDB5 \$ 914.00	PSDP5 \$ 987.00	PSBB5 \$ 987.00
6' Portable with back	265 Lbs PSDB6 \$ 1,099.00	PSDP6 \$ 1,215.00	PSBB6 \$ 1,215.00
8' Portable with back	300 Lbs PSDB8 \$ 1,267.00	PSDP8 \$ 1,348.00	PSBB8 \$ 1,348.00

U Leg Bench with Back

With 3" tubular steel legs and one piece 11 ga perforated steel seat and back. This comfortable bench has a durable thermoplastic coating and pre-drilled holes in the base plate for permanent mounting.

PSURB6TP	6' U-Leg bench with back	260 Lbs	\$ 986.00
PSURB8TP	8' U-leg bench with back	282 Lbs	\$ 1,078.00

U Leg Backless Bench

Ideal for malls, streetscapes, parks, and schools. Extra wide seat is made of 11 ga perforated steel with 3" tubular legs that are drilled for surface mounting. The entire unit is thermoplastic coated.

PSURBB4TP	4' U-leg bench backless	118 Lbs	\$ 703.00
PSURBB6TP	6' U-leg bench backless	138 Lbs	\$ 829.00

Backless Bench Available



More information on perforated colors on page 94.



Black Brown Navy Green Lt.Blue Burgundy BlkGreen Red Purple Teal Orange Yellow Gray Beige Granite Sandstone

Perforated Steel Site Furnishings

Perforated Picnic Table

Weather resistant thermoplastic coating on 11 ga tops and seats. With a 2 3/8" O.D. steel tube frame comes with a black powder coat finish. The combination makes this an attractive and durable table for any outdoor setting.

MC6PSTP	6' Portable table	225 Lbs	\$ 815.00
MC8PSTP	8' Portable table	271 Lbs	\$ 862.00
MC8TPADA	8' Portable table ADA	238 Lbs	\$ 839.00
MC10PSTP	10' Portable table	388 Lbs	\$ 1,354.00



46" Round Perforated Table

Thermoplastic tops and seats that are made of 11 ga perforated steel that comfortably seat eight around a 46" top. The 1 5/8" O.D. tube legs are powder coated black. The 3 seat model is used for ADA wheelchair accessibility.

MC46PSRTP	46" Portable table	257 Lbs	\$ 899.00
MC46PSRTPADA2	46" Portable table, 2 seat	210 Lbs	\$ 762.00
MC46PSRTPADA3	46" Portable table, 3 seat	233 Lbs	\$ 1,168.00



Square Table

Portable thermoplastic perforated steel square table.

MC46PSTP	46" Sq. Square Table	259 Lbs	\$ 869.00
MC46PSTPDP	46" Dog Park Table	259 Lbs	\$ 964.00
MC46PSTPADA2	46" Sq. Square, 2 seat	245 Lbs	\$ 960.00
MC46PSTPADA3	46" Sq. Square, 3 seat	251 Lbs	\$ 914.00



32 Gal. Perf. Receptacle

This 11 ga metal has thermoplastic coating in variety of colors. Lids and liners sold separately.

32 Gal. Perf.

32 Gal. Dog Trash

32 Gal Perf round	81 Lbs	MCPS32LR	\$ 336.00	MCPSDP32	\$ 399.00
Surface Mount	6 Lbs	MCPSLRSM	\$ 59.00	MCPSPDSM	\$ 59.00
In Ground Mount	6 Lbs	MCPSLRIG	\$ 59.00	MCPSPDIG	\$ 59.00



Black Plastic liner for use with 32 Gal. Perf. and 32 Gal. Custom Litter receptacles.
MCLR32L
9 Lbs
\$ 49.00

Perforated Colors:

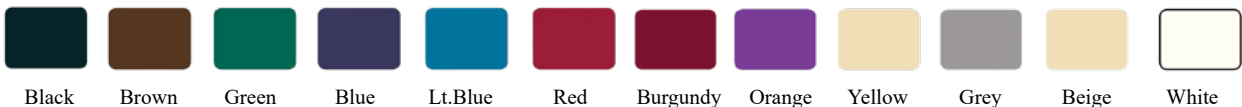

More Products Online!

WWW.KAYPARK.COM

Strap Steel Amenities



A.



B.



C.



D.

*Custom Color Available
\$ 125.00 Per Color*



E.

*Beautiful your street scape with
Maintenance-FREE
Elegant Strap Steel*

A. 32 Gal recept w/snuffer top	340Lbs	SSHRLRCS	\$1,274.00
B. Cigarette Snuffer	80 Lbs	SSCS	\$1,577.00
C. 32 gal "V" Style litter receptacle	250 Lbs	SSVSLR32	\$1,199.00
C. "V" Style cigarette snuffer w/bowl	80 Lbs	SSVCS	\$609.00
D. 48" Backless Bench	150 Lbs	SSABB48	\$762.00
D. 72" Backless Bench	180 Lbs	SSABB72	\$1,099.00
E. 36"W x 24"H Planter	300 Lbs	SSAP362432	\$1,087.00
F. 48" Contour Bench	240 Lbs	SSCB48	\$1,147.00
F. 72" Contour Bench	300 Lbs	SSCB72	\$1,577.00



F.

Don't forget the bike racks.
See page 62-65.



A. 48" Bench

B.

NEW!



C.

Powder Coat Colors:

White	Tan	Bronze	Brown	Black	Royal Blue	Evergreen	Hunter Green
-------	-----	--------	-------	-------	------------	-----------	--------------



G.

Recycling Bins come complete w/liners, specify compartment wording



48" Backless Bench D.

Ashtray top



E.

Rain Cover



F.

A. 48" Bench with back	170 Lbs	IVB48PC	\$1,049.00
A. 60" Bench with back	190 Lbs	IVB60PC	\$1,175.00
A. 72" Bench with back	210 Lbs	IVB72PC	\$1,331.00
A. 96" Bench with back	260 Lbs	IVB96PC	\$1,823.00
B. 45 Gal recept Flat Lid	340 Lbs	IVILRPC	\$1,213.00
C. 30" dia. x 25"h w/liner	290 Lbs	IVPLANTER	\$1,019.00

D. 48" Backless Bench	115 Lbs	IVBB48PC	\$881.00
D. 60" Backless Bench	140 Lbs	IVBB60PC	\$999.00
D. 72" Backless Bench	165 Lbs	IVBB72PC	\$1,147.00
D. 96" Backless Bench	215 Lbs	IVBB96PC	\$1,556.00
E. Ashtray top/rain cover	10 Lbs	IVAT	\$179.00
F. Rain Cover	12 Lbs	IVATC	\$171.00
G. 3 Bin Oval Recycling	390 Lbs	IVRC3R	\$1,998.00

Solar Charge Station



Solar Charge Station

- Standard 4 USB ports, 2 Apple, 2 Android
- 2.1 amp fast charge
- 100 watt solar panel
- 7 amp hour sealed lead acid battery back-up
- Gray or black color hub housing
- 1 1/2" O.D. Pole

Great For:

*Malls, Courtyards, Parks, Resorts, Pools
Amusements, Schools, Colleges, Fairs*

KCSSUF	Umbrella Kit	156 Lbs	\$ 2,167.00
KCSSSR	Ring Kit	165 Lbs	\$ 1,831.00

If purchased to go with a concrete table an umbrella bracket is required

Table Purchased Separately

*Ring Kit
Shown with
Fiberglass
Table*



*Makes places people friendly
Allows people to charge multiple devices!
Keeps people at your outdoor facility longer!
Great addition to any venue!*

Powder Coating Colors:



RepairSTAN™ Bicycle Repair Stand

- 52 5/8"H x 18"W x 1 7/8" L
- Allen Wrenches: 2.5, 3, 4, 5, 6, 8mm
- Adjustable Wrench
- Headset Wrench
- Pedal Wrench
- Open Wrenches 8, 9, 10, 11mm
- Tire Lever
- Phillips Screwdriver
- Straight Screwdriver
- Surface mount plate for bolt down

MBRSCM Powder Coated Repair Stand 80 Lbs **\$ 695.00**

MBRSGM Galvanized Repair Stand 80 Lbs **\$ 695.00**



Phil Up Air Pump

- 5"H x 12"W x 14" L
- Steel housing with an aluminum handle
- Presta and Schrader valve head
- 160 PSI Air Gauge
- Electro polish stainless finish
- Surface mount plate for bolt down

MBRSSM Fill Up Station 22 Lbs **\$ 797.00**



Vertical Single Bike Storage

- 28" H x 28" D x 3 1/4" W
- 1/2" and 5/8" Steel Bar
- Mounts one bicycle vertically to the wall of a garage, basement, or other storage area.
- Galvanized "G" or Powder Coated Finish "C"

MBBSVIGWM Galvanized Wall Rack 7 Lbs **\$ 79.00**

MBBSVICWM Powder Coated Wall Rack 7 Lbs **\$ 89.00**

*These are ideal for
apartment/residential use*



Bike Racks

Kay Park Recreation offers a variety of bicycle parking racks, including vertical bar style bike racks, loop style bicycle racks, as well as some unique low profile, circle, horseshoe and triangle bicycle parking racks. A similar item is offered specifically for skateboards and scooters. We have bicycle parking racks for any application.



Vinyl Plastisol T-Post Bike Rack

Made of 2" pipe tube and 1/2" loops. Base is made of 3/16" HR steel plate. PVC coated with UV and fungus resistant plastisol to a thickness of 1/8".

TPBRVPSM Surface Mount Bike Rack 19 Lbs \$ 169.00

*Thicker, Softer Protection
help prevent scrapes and cuts.*



Than Thermoplastic

Quality Thick Vinyl Plastisol:



Black Brown Green Blue Purple Burgundy Red Yellow Gray Almond



WARNING: Cancer and Reproductive Harm www.P65Warnings.com



Horseshoe Style Bike Rack

Made of 2 3/8" O.D. steel pipe with surface mount base plate for bolting down. Available in hot dip galvanized or powder coated finish. Specify powder coat color. 2 bikes can be locked to it. One each side.

MHS2GSM Galvanized Horseshoe Rack 32 Lbs \$ 288.00
MHS2CSM Powder Coated Horseshoe Rack 32 Lbs \$ 314.00

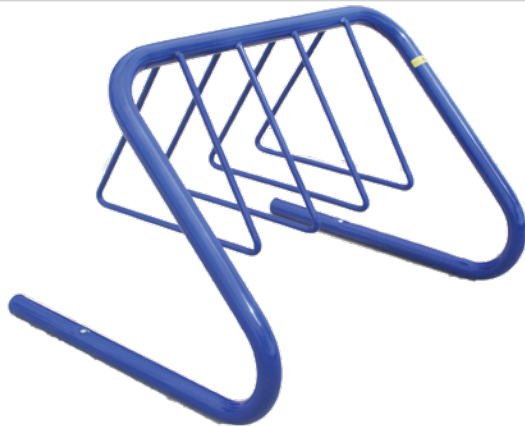

Triangle Style Bike Rack

A unique design made of 2 3/8" O.D. steel tubing frame with 3/4" solid steel rod triangles to lock bikes to. Comes in a variety of powder coat color finishes. Bike spaces are figured one between each triangle and one on each side of the end frames. (Loading from both sides.) So this bike rack can hold 7 bikes.

TRBR7C 50" Length, 7 Spaces 85 Lbs \$ 775.00

Powder Coating Colors:



White Tan Yellow Shamrock Green Forest Green Lexing Green Red Burgundy Royal Blue Black

1 5/8" O.D. Loop Style Bike Rack

A popular modern design and economically priced. Made of 1 5/8" O.D. schedule 40 pipe, these units come with either a hot-dip galvanized finish, or powder coated. Custom colors are available to match your surroundings. Comes as either an in-ground mount or with flanges for surface mounting. (The number of spaces is figured at one bicycle per loop and one at each end.)

In Ground

Length	Spaces	Loops		<u>Galvanized</u>		<u>Powder Coated</u>	
15"	3	1	12 Lbs	611GIG	\$79.00	611CIG	\$99.00
39"	5	3	28 Lbs	613GIG	\$202.00	613CIG	\$236.00
71"	7	5	43 Lbs	615GIG	\$280.00	615CIG	\$325.00
88"	9	7	70 Lbs	617GIG	\$383.00	617CIG	\$438.00
113"	11	9	86 Lbs	619GIG	\$472.00	619CIG	\$540.00

Surface Mount

Length	Spaces	Loops		<u>Galvanized</u>		<u>Powder Coated</u>	
15"	3	1	13 Lbs	611GSM	\$135.00	611CSM	\$151.00
39"	5	3	36 Lbs	613GSM	\$259.00	613CSM	\$292.00
71"	7	5	51 Lbs	615GSM	\$338.00	615CSM	\$393.00
88"	9	7	70 Lbs	617GSM	\$438.00	617CSM	\$493.00
113"	11	9	92 Lbs	619GSM	\$529.00	619CSM	\$607.00

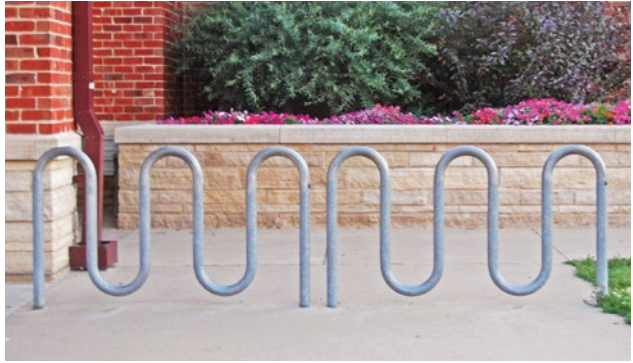

2 3/8" O.D. Loop Style Bike Rack

Super heavy duty modern design unit. This model is made of 2 3/8" O.D. schedule 40 pipe, with either a hot-dip galvanized finish, or powder coated. Custom colors are available. Comes as either an in-ground mount, or with flanges for surface mounting. (The number of spaces is figured at one bicycle per loop and one at each end.)

In Ground

Length	Spaces	Loops		<u>Galvanized</u>		<u>Powder Coated</u>	
15"	3	1	25 Lbs	621GIG	\$134.00	621CIG	\$146.00
39"	5	3	58 Lbs	623GIG	\$338.00	623CIG	\$388.00
71"	7	5	83 Lbs	625GIG	\$460.00	625CIG	\$506.00
88"	9	7	109 Lbs	627GIG	\$574.00	627CIG	\$640.00
113"	11	9	134 Lbs	629GIG	\$686.00	629CIG	\$754.00

Surface Mount

Length	Spaces	Loops		<u>Galvanized</u>		<u>Powder Coated</u>	
15"	3	1	25 Lbs	621GSM	\$190.00	621CSM	\$209.00
39"	5	3	58 Lbs	623GSM	\$405.00	623CSM	\$440.00
71"	7	5	83 Lbs	625GSM	\$517.00	625CSM	\$562.00
88"	9	7	109 Lbs	627GSM	\$640.00	627CSM	\$688.00
113"	11	9	134 Lbs	629GSM	\$743.00	629CSM	\$810.00



Powder Coating Colors:

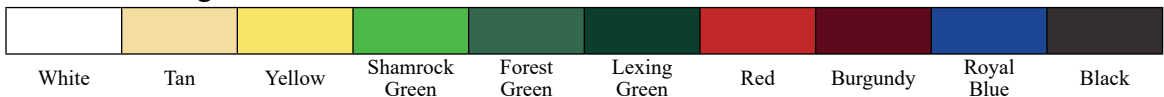

Vertical Bar Bike Racks



Powder Coat Colors:

Black
Red
Burgundy
Forest Green
Royal Blue
Yellow
White
Tan

Custom color available upon agreed RAL number.

Vertical Bar Bike Racks

- 1 5/8" O.D. Frame
- 1" O.D. Tube Stall
- Powder coated 'C'
- Specify Color

1052 5' Galvanized 8 Spaces Bike Rack Only



"J" Style Bike Racks

1052	5' galvanized, 8 spaces	74 Lbs	\$ 369.00
1052C	5' powder coated., 8 spaces	74 Lbs	\$ 477.00
1082	8' galvanized., 14 spaces	93 Lbs	\$ 438.00
1082C	8' powder coated, 14 spaces	93 Lbs	\$ 573.00
1102	10' galvanized, 18 spaces	122 Lbs	\$ 486.00
1102C	10' powder coated., 18 spaces	122 Lbs	\$ 648.00
1162	16' galvanized, 28 spaces	174 Lbs	\$ 799.00
1162C	16' powder coated., 28 spaces	174 Lbs	\$ 1,069.00
1202	20' galvanized, 36 spaces	234 Lbs	\$ 998.00
1202C	20' powder coated., 36 spaces	234 Lbs	\$ 1,324.00
1100	Anchor	3 Lbs	\$ 24.00

American Made Quality with an Affordable Price



"W" Style Bike Racks

7052	5' galvanized, 8 spaces	82 Lbs	\$ 320.00
7052C	5' powder coated., 8 spaces	82 Lbs	\$ 428.00
7082	8' galvanized., 14 spaces	98 Lbs	\$ 374.00
7082C	8' powder coated, 14 spaces	98 Lbs	\$ 509.00
7102	10' galvanized, 18 spaces	124 Lbs	\$ 460.00
7102C	10' powder coated., 18 spaces	124 Lbs	\$ 620.00
7162	16' galvanized, 28 spaces	180 Lbs	\$ 732.00
7162C	16' powder coated., 28 spaces	180 Lbs	\$ 1,002.00
7202	20' galvanized, 36 spaces	239 Lbs	\$ 916.00
7202C	20' powder coated., 36 spaces	239 Lbs	\$ 1,240.00
1100	Anchor	3 Lbs	\$ 24.00



"A" Style Bike Racks

5052	5' galvanized, 8 spaces	83 Lbs	\$ 351.00
5052C	5' powder coated., 8 spaces	83 Lbs	\$ 459.00
5082	8' galvanized., 14 spaces	98 Lbs	\$ 405.00
5082C	8' powder coated, 14 spaces	98 Lbs	\$ 540.00
5102	10' galvanized, 18 spaces	126 Lbs	\$ 489.00
5102C	10' powder coated., 18 spaces	126 Lbs	\$ 651.00
5162	16' galvanized, 28 spaces	182 Lbs	\$ 784.00
5162C	16' powder coated., 28 spaces	182 Lbs	\$ 1,054.00
5202	20' galvanized, 36 spaces	241 Lbs	\$ 925.00
5202C	20' powder coated., 36 spaces	241 Lbs	\$ 1,240.00
1100	Anchor	3 Lbs	\$ 24.00



- *Economical*
- *Maintenance-free*



Low Profile Style Bike Rack

- 1 1/16" O.D. 14 gauge High Tensile Galvanized Frame
- Anchor bolts sold separately.

	Lgth	Spaces			
4052	5'	6 Double Side	54 Lbs	\$218.00	
4052C	5'	6 Double Side	54 Lbs	\$307.00	
4102	10'	12 Double Side	107 Lbs	\$418.00	
4102C	10'	12 Double Side	107 Lbs	\$615.00	
4100	-	- Anchor Set	3 Lbs	\$22.00	

Powder Coat Colors:
Black
Red
Burgundy
Forest Green
Royal Blue
Yellow
White
Tan

Custom color available upon agreed RAL number.



* Quick Ship Galvanized ONLY*

Heritage Steel Bike Rack

- "Old World" design
- 3/4" Solid Square Steel
- 12" High
- Specify color when ordering

SSABR6 6' Length, 5 spaces each side 175 Lbs \$ 949.00



3102P Shown

Circle Style Bike Rack

- Circular Wheel Stalls 5/8" Steel Rod
- 2 3/8" O.D. Galvanized Frame
- 12" High
- Breaks Down to Reduce Freight

Lgth	Spaces			In Ground	Surface Mount	Portable	
5'	4	Single Side	61 Lbs	3051 \$276.00	3051SM \$312.00	3051P \$312.00	
5'	4	Single Side	61 Lbs	3051C \$360.00	3051SMC \$396.00	3051PC \$396.00	
5'	8	Double Side	87 Lbs	3052 \$376.00	3052SM \$407.00	3052P \$399.00	
5'	8	Double Side	87 Lbs	3052C \$459.00	3052SMC \$490.00	3052PC \$483.00	
10'	7	Single Side	96 Lbs	3101 \$443.00	3101SM \$474.00	3101P \$467.00	
10'	7	Single Side	96 Lbs	3101C \$539.00	3101SMC \$570.00	3101PC \$563.00	
10'	14	Double Side	140 Lbs	3102 \$581.00	3102SM \$607.00	3102P \$615.00	
10'	14	Double Side	140 Lbs	3102C \$677.00	3102SMC \$703.00	3102PC \$711.00	

Help Make Your Area Bike Friendly!

Portable Benches - With Back



62PG-PS
SYP Wood

Portable benches are 2 3/8" O.D. galvanized tube with 1 1/16" cross brace and portable leg style to allow for mobility. These benches are perfect for indoor or outdoor use and drilled to accept 2" x 4" slats or 2" x 10" planks. Great for parks, locker rooms, ball diamonds, or soccer fields etc.

Treated SYP Wood 2x4" Slat Bench

62PGPS	6' Treated SYP 2x4"	107 Lbs	\$ 234.00
82PGPS	8' Treated SYP 2x4"	127 Lbs	\$ 256.00



62PGAS
Aluminum Slats

Aluminum 2x4" Slat Bench

62PGAS	6' Aluminum, 2x4" slats	80 Lbs	\$ 404.00
82PGAS	8' Aluminum, 2x4" slats	90 Lbs	\$ 491.00

Same Durable Frame Just Choose Your Plank!



62PGP
SYP Wood Plank

Treated SYP Wood 2x10" Plank Bench

62PGP	6' Treated SYP, 2x10"	96 Lbs	\$ 211.00
82PGP	8' Treated SYP, 2x10"	111 Lbs	\$ 227.00
152PGP	15' Treated SYP, 2x10"	187 Lbs	\$ 410.00

Frame Plus Hardware

2PG26	FRAME ONLY for 6'	48 Lbs	\$ 149.00
2PG28	FRAME ONLY for 8'	50 Lbs	\$ 149.00
2PG315	FRAME ONLY for 15'	76 Lbs	\$ 245.00

Change "G" to "C" for powder coat frame.
2 Legs Can be powder coated for \$20.00
3 Legs Can be powder coated for \$30.00



82PGRPS
Recycled Plastic

Recycled Plastic 2x4" Slat Bench

62PGRPS	6' Recycled plastic, 2x4" 2 Legs	110 Lbs	\$ 476.00
82PGRPS	8' Recycled plastic, 2x4" 3 Legs	153 Lbs	\$ 697.00



Steel Reinforced Recycled Plastic:



Brown Cedar Gray

Portable Benches - With Back

See Plank Options Page 94

Recycled Plastic 2x10" Plank Bench

62PGRRP	6' Recycled plastic, 2x10"	108 Lbs	\$ 376.00
82PGRRP	8' Recycled plastic, 2x10" (3 Legs)	167 Lbs	\$ 533.00



62PG-RRP
Recycled Plastic

Aluminum 2x10" Plank Bench

62PGA	6' Aluminum, 2x10"	69 Lbs	\$ 263.00
82PGA	8' Aluminum, 2x10"	80 Lbs	\$ 296.00
152PGA	15' Aluminum, 2x10"	127 Lbs	\$ 535.00
212PGA	21' Aluminum, 2x10"	165 Lbs	\$ 749.00



Same Durable Frame Just Choose Your Plank!



Shown: 62PCA
Aluminum Plank
Powder Coat Price Pg. 66

Fiberglass 2x10" Plank Bench

62PGF	6' Fiberglass, 2x10"	101 Lbs	\$ 391.00
82PGF	8' Fiberglass, 2x10"	119Lbs	\$ 535.00
152PGF	15' Fiberglass, 2x10"	189 Lbs	\$ 993.00

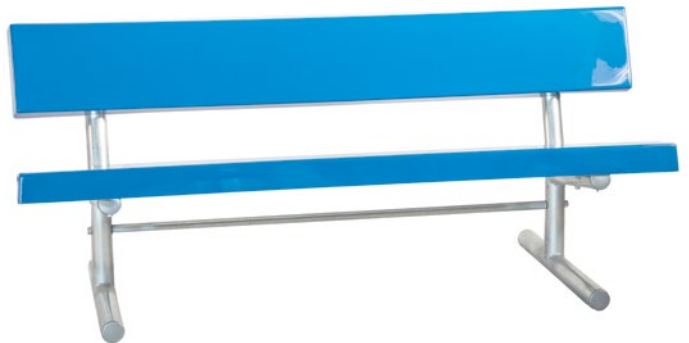
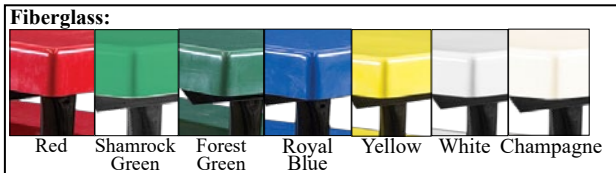

Shown: 62PGF
Fiberglass

Vinyl Plastisol 2x10" Plank Bench

62PGVP	6' Vinyl Plastisol 2x10"	130 Lbs	\$ 497.00
82PGVP	8' Vinyl Plastisol 2x10"	147 Lbs	\$ 572.00
152PGVP	15' Vinyl Plastisol 2x10"	260 Lbs	\$ 1,054.00

Impact Absorbing, Kid Friendly Coating!

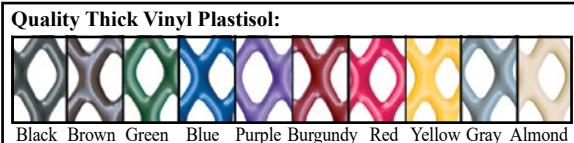

Shown: 62PCVP
Vinyl Plastisol
Powder Coat Price Pg. 66



WARNING: Cancer and Reproductive Harm www.P65Warnings.com

Portable Benches - NO Back

Portable benches are 2 3/8" O.D. galvanized tube with 1 1/16" cross brace and portable leg style to allow for mobility. These benches are perfect for indoor or outdoor use. Great for parks, locker rooms, ball diamonds, or soccer fields etc. These benches are only available with 2" x 10" plank seats, 6', 8', or 15' 15 foot bench has 3 legs.



Shown: 62PGLP Treated SYP Wood

Shown: 62PGLRRP Recycled Plastic



Treated SYP Wood 2x10" Plank Bench

62PGLP	6' Treated SYP, 2x10"	54 Lbs	\$ 133.00
82PGLP	8' Treated SYP, 2x10"	65 Lbs	\$ 144.00
152PGLP	15' Treated SYP, 2x10"	105 Lbs	\$ 245.00

Recycled Plastic 2x10" Plank Bench

62PGLRRP	6' Recycled plastic, 2x10"	54 Lbs	\$ 290.00
82PGLRRP	8' Recycled plastic, 2x10"	86 Lbs	\$ 316.00

Aluminum 2x10" Plank Bench

62PGLA	6' Aluminum, 2x10"	42 Lbs	\$ 153.00
82PGLA	8' Aluminum, 2x10"	49 Lbs	\$ 176.00
152PGLA	15' Aluminum, 2x10"	74 Lbs	\$ 299.00

Frame Plus Hardware

2PGL26	FRAME ONLY for 6'	32 Lbs	\$ 107.00
2PGL28	FRAME ONLY for 8'	34 Lbs	\$ 107.00
2PGL315	FRAME ONLY for 15'	49 Lbs	\$ 173.00

Change "G" to "C" for powder coat frame.
 2 Legs Can be powder coated for \$20.00
 3 Legs Can be powder coated for \$30.00

Fiberglass 2x10" Plank Bench

62PGLF	6' Fiberglass, 2x10"	64 Lbs	\$ 271.00
82PGLF	8' Fiberglass, 2x10"	95 Lbs	\$ 366.00
152PGLF	15' Fiberglass, 2x10"	113 Lbs	\$ 583.00

Fiberglass:

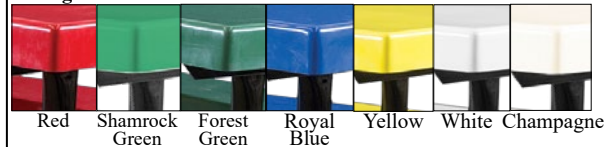

Vinyl Plastisol 2x10" Plank Bench

62PGLVP	6' Vinyl Plastisol 2x10"	71 Lbs	\$ 262.00
82PGLVP	8' Vinyl Plastisol 2x10"	81 Lbs	\$ 292.00
152PGLVP	15' Vinyl Plastisol 2x10"	139 Lbs	\$ 598.00

Impact Absorbing, Kid Friendly Coating!

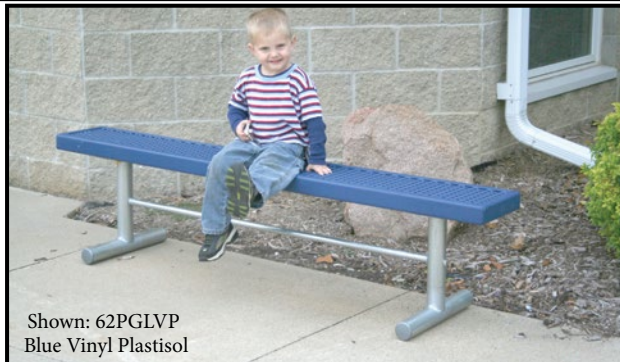

Shown: 62PGLVP Blue Vinyl Plastisol

Quality Thick Vinyl Plastisol:

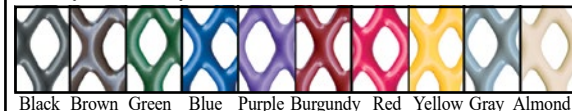

Than Thermoplastic

WARNING:
 Cancer and Reproductive Harm
 www.P65Warnings.com
Fiberglass & Vinyl Plastisol

Stationary Benches - NO Back

Stationary benches are 2 3/8" O.D. galvanized tube with in-ground leg style to allow for permanent installation. These benches are perfect for indoor or outdoor use. Great for parks, locker rooms, ball diamonds, soccer fields, etc. These benches are only available in 2" x 10" planks. Add \$26.00 to price for surface mount and "SM" to the model number.

Treated SYP Wood 2x10" Plank Bench

62SGLP	6' Treated SYP, 2x10"	54 Lbs	\$ 122.00
82SGLP	8' Treated SYP, 2x10"	62 Lbs	\$ 131.00
152SGLP	15' Treated SYP, 2x10"	103 Lbs	\$ 219.00



Recycled Plastic 2x10" Plank Bench

62SGLRRP	6' Recycled plastic, 2x10" 2 legs	48 Lbs	\$ 260.00
82SGLRRP	8' Recycled plastic, 2x10" 3 Legs	72 Lbs	\$ 295.00



Aluminum 2x10" Plank Bench

62SGLA	6' Aluminum, 2x10"	41 Lbs	\$ 138.00
82SGLA	8' Aluminum, 2x10"	44 Lbs	\$ 159.00
152SGLA	15' Aluminum, 2x10"	69 Lbs	\$ 274.00



Frame Only

2SGL26	FRAME ONLY for 6'	28 Lbs	\$ 82.00
2SGL28	FRAME ONLY for 8'	28 Lbs	\$ 82.00
2SGL315	FRAME ONLY for 15'	42 Lbs	\$ 113.00

Change "G" to "C" for powder coat frame.
 2 Legs Can be powder coated for \$20.00
 3 Legs Can be powder coated for \$30.00

Fiberglass 2x10" Plank Bench

62SGLF	6' Fiberglass, 2x10"	65 Lbs	\$ 271.00
82SGLF	8' Fiberglass, 2x10"	65 Lbs	\$ 355.00
152SGLF	15' Fiberglass, 2x10"	98 Lbs	\$ 561.00

Commercial Quality



Vinyl Plastisol 2x10" Plank Bench

62SGLVP	6' Vinyl Plastisol 2x10"	69 Lbs	\$ 241.00
82SGLVP	8' Vinyl Plastisol 2x10"	78 Lbs	\$ 275.00
152SGLVP	15' Vinyl Plastisol 2x10"	140 Lbs	\$ 553.00

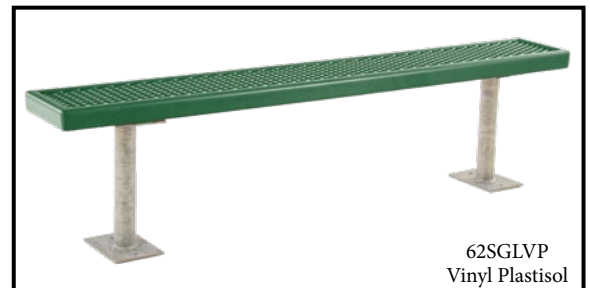

**Thicker,
Softer Protection
For Long-Lasting Quality.**

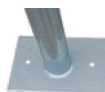

Surface Mount
 Add \$26.00 to price for surface mount and "SM" to the model number.

See Plank Options Page 94

Stationary Benches - With Back



Shown: 62SG-PS SYP Wood

Stationary Benches With Back

Stationary Benches are 2 3/8" O.D. galvanized tube with in-ground leg style to allow for permanent installation. These benches are perfect for indoor or outdoor use. Great for parks, locker rooms, ball diamonds, soccer fields, etc. Add \$26.00 to price for **surface mount** and "SM" to the model number.

Treated SYP Wood 2x4" Slat Bench

62SGPS	6' Treated SYP 2x4"	98 Lbs	\$ 208.00
82SGPS	8' Treated SYP 2x4"	117 Lbs	\$ 229.00

Aluminum 2x4" Slat Bench

62SGAS	6' Aluminum, 2x4" slats	70 Lbs	\$ 374.00
82SGAS	8' Aluminum, 2x4" slats	80 Lbs	\$ 464.00



Shown: 62SGAS Aluminum Slats



Shown: 62SGP SYP Wood Plank

Treated SYP Wood 2x10" Plank Bench

62SGP	6' Treated SYP, 2x10"	87 Lbs	\$ 179.00
82SGP	8' Treated SYP, 2x10"	103 Lbs	\$ 195.00
152SGP	15' Treated SYP, 2x10"	180 Lbs	\$ 361.00

Frame Only

2SG26	FRAME ONLY for 6'	35 Lbs	\$ 116.00
2SG28	FRAME ONLY for 8'	35 Lbs	\$ 116.00
2SG315	FRAME ONLY for 15'	60 Lbs	\$ 153.00

2 Legs Can be powder coated for \$20.00

3 Legs Can be powder coated for \$30.00



Shown: 82SGRPS Cedar Recycled Plastic

Recycled Plastic 2x4" Slat Bench

62SGRPS	6' Recycled plastic, 2x4" 2 Legs	100 Lbs	\$ 432.00
82SGRPS	8' Recycled plastic, 2x4" 3 Legs	145 Lbs	\$ 626.00



Steel Reinforced Recycled Plastic:



Brown Cedar Gray

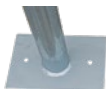

Surface Mount
Add \$26.00 to price for surface mount and "SM" to the model number.

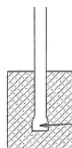

Standard In-Ground Mount

Stationary Benches - With Back

Recycled Plastic 2x10" Plank Bench

- 62SGRRP** 6' Recycled plastic, 2x10" 2 Legs 85 Lbs \$ 333.00
82SGRRP 8' Recycled plastic, 2x10" 3 Legs 130 Lbs \$ 463.00



Aluminum 2x10" Plank Bench

- 62SGA** 6' Aluminum, 2x10" 61 Lbs \$ 233.00
82SGA 8' Aluminum, 2x10" 98 Lbs \$ 267.00
152SGA 15' Aluminum, 2x10" 111 Lbs \$ 544.00
212SGA 21' Aluminum, 2x10" 136 Lbs \$ 681.00



Fiberglass 2x10" Plank Bench

- 62SGF** 6' Fiberglass, 2x10" 93 Lbs \$ 359.00
82SGF 8' Fiberglass, 2x10" 109 Lbs \$ 508.00
152SGF 15' Fiberglass, 2x10" 169 Lbs \$ 969.00

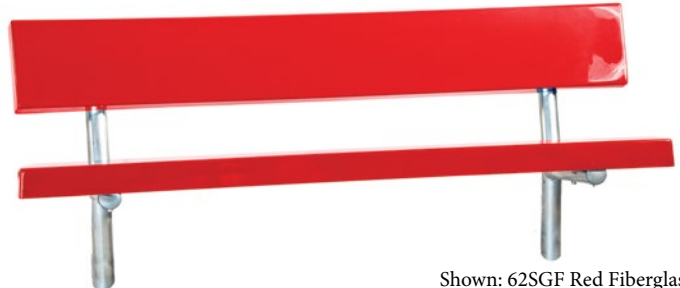
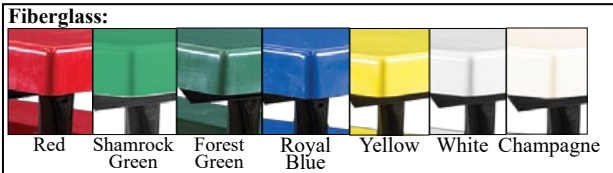

Vinyl Plastisol 2x10" Plank Bench

- 62SGVP** 6' Vinyl Plastisol 2x10" 121 Lbs \$ 476.00
82SGVP 8' Vinyl Plastisol 2x10" 136 Lbs \$ 518.00
152SGVP 15' Vinyl Plastisol 2x10" 253 Lbs \$ 985.00

*Thicker,
Softer Protection
For Long-Lasting Quality.*

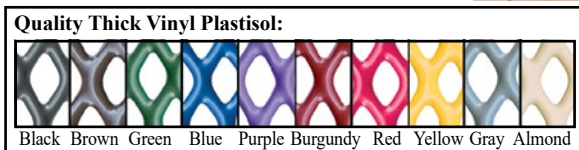

WARNING:
Cancer and
Reproductive Harm
www.P65Warnings.com
Fiberglass & Vinyl Plastisol

Dugout Benches and Crowd Barricades/Fencing



Double Shelf-Back Players Bench

A frame that is fabricated of 2" x 2" x 3/16" aluminum angle for extra long life and rigidity. The seat is a 2" x 12" wide. The double wide self is designed for players who like to sit up on the backrests of benches, as well as providing a place to put gloves, bat bags, etc. up off the ground. Assembly required.

15DSBPBA	15' Double shelf-back bench	196 Lbs	\$ 976.00
21DSBPBA	21' Double shelf-back bench	275 Lbs	\$ 1,327.00
27DSBPBA	27' Double shelf-back bench	357 Lbs	\$ 1,833.00



Scorers Table

A frame that is fabricated of 2 3/8" O.D. pipe and hot dip galvanized after fabrication. Center cleat holds top level and the 1 5/16" cross braces stabilize this extra heavy duty frame. Tops and seats are Anodized Aluminum planks close proximity to the action. Available in 6' or 8' lengths. Call for custom length models. School color powder coated aluminum planks available at additional charge.

6J2GA1S	6' One sided scorer table	152 Lbs	\$ 490.00
8J2GA1S	8' One sided scorer table	165 Lbs	\$ 544.00



Crowd Barricade

- Continuous interlocking barricade
- Easy set-up and tear down
- Ballasted with 3 gallons of water to a filled weight
- UV resistant polyethylene
- Advertising space
- Green or Yellow

WALL4296	42" H x 96" L crowd barricades	33 Lbs	\$ 170.00
WALLGATE	Gate barricade	18 Lbs	\$ 113.00



Sport Fence

- Light-weight temporary fence
- PVC pipe and mesh panels
- Break-away mechanism
- Available in white or black
- No special tools required

Great for multiple applications:

- Multiple use athletic fields
- Special Events
- Crowd Control
- Construction Blockades

SFI42120	42" H x 120" L Sport barricade	22 Lbs	\$ 170.00
-----------------	--------------------------------	--------	------------------

Bleacher Sun Shades

Keep patrons at your next event longer by shading them from the baking hot sun! Providing shade can reduce the temperature on the bleacher by nearly 20 degrees Fahrenheit and give fans up to 95% UV protection! Our shade fabric is woven, high-density polyethylene and is warranted for five years against failure due to rot, UV deterioration or faulty workmanship. The framework is top-quality, cold-rolled, flo-coated galvanized steel. It comes with embedment poles and easy installation instructions. **(Surface mount poles are optional. Add 'SM' to the model number and add \$325.00 to the price.)** Note: Shades are not designed for snow loads and must be removed in winter and when forecasted winds are over 75 mph. Standard colors below. Custom colors available.



Shades for 10 Row Bleachers - 15', 21', or 27'

Model	Dim.	Typical Bleacher Dim.	Typical # of Occupants	Weight	Price
BS2218	18' L x 22' D x 12'H	15' L x 20' W	100	480 Lbs	\$ 8,899.00
BS2422	24' L x 22' D x 12'H	21' L x 20' W	140	598 Lbs	\$ 11,539.00
BS3022	30' L x 22' D x 12'H	27' L x 20' W	180	651 Lbs	\$ 12,968.00

Shade Covers Colors:

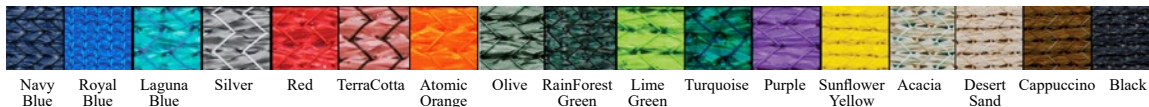



Shades for 5 Row Bleachers - 15', 21', or 27'

Model	Dim.	Typical Bleacher Dim.	Typical # of Occupants	Weight	Price
BS1812	18' L x 12' D x 9'H	15' L x 9' W	50	355 Lbs	\$ 5,573.00
BS2412	24' L x 12' D x 9'H	21' L x 9' W	70	410 Lbs	\$ 6,387.00
BS3012	30' L x 12' D x 9'H	27' L x 9' W	90	500 Lbs	\$ 6,981.00

Dugout/Scorers Table Shade Covers

Offered to meet the increasing demand to provide shade to players to give them a break from the baking hot sun! Providing shade reduces the temperature in the dugout, gives them a break from harmful UV rays. Shade fabric is super-tough woven, high density polyethylene and is warranted for five years against failure due to rot, UV deterioration, or faulty workmanship. The framework is top-quality, cold rolled, flo-coat galvanized shell. It comes with poles for in-ground embedding as standard. **(Surface mount plate poles are optional. Add 'SM' to the model number and add \$325.00 to the price.)** Note: Shades are not designed for snow loads and must be removed in winter and when forecasted winds are over 75 mph. Standard colors below. Custom colors available.

DS1012G	10' W x 12' L x 8' H	232 Lbs	\$ 4,124.00
DS1016G	10' W x 16' L x 8' H	260 Lbs	\$ 4,589.00
DS1018G	10' W x 18' L x 8' H	275 Lbs	\$ 5,198.00
DS1020G	10' W x 20' L x 8' H	295 Lbs	\$ 5,414.00



Bleacher Options



Design standards: The bleachers shall be designed to support, in addition to their weight, a uniformly distributed live load of not less than 120 pounds per square foot of gross horizontal projection of the bleachers. All seat and foot plank members shall be designed to support no less than 125 pounds per linear foot, over a 6 foot span, multi-span condition. Bleachers shall be designed to resist, with or without live load, horizontal wind load of 30 pounds per square foot of gross vertical projection. They shall be designed to resist, in addition to the live load, sway forces applied to the seats, in a direction parallel to the direction of the seat plank, 24 pounds per linear foot of seat plank, and separately, in a direction perpendicular to the direction of seats, 10 pounds per linear foot of seat plank.



Kay's Vertical Bar Guard Rails (V4) 4" Spaced

Kay Park's Vertical Bar Guard Rails (Patented #404-141) were introduced to the outdoor portable bleacher industry, an innovation whose time has come. Vertical galvanized steel bars eliminate the "ladder effect" and a possible toe - hold for climbing on the guardrails. The possibility of accidents and serious injury and liability can be reduced by using vertical bar railing. This is part of Kay Park's continuing effort to make good products even better since 1954. We urge you to plan your purchases on the side of safety. Please note that Kay Park's 3 & 4 Row Low Rise Bleachers are EXEMPT from current guard rail rules because they are less than 30" high. Model numbers with 'V4' include Vertical Bar Guard Rails.



Full Width Footboards (F4)

Many of the various recent codes for outdoor bleacher seating require any opening more than 30" above the ground be small enough so that a 4" sphere cannot pass through. Kay Park has designed a system using two footboards and one riser plank. This system fills the space underneath the seats from the 4th row up to meet the 4" sphere guideline. Double footboards add a lot of comfort and peace of mind to the spectators. Model numbers with 'F4' include the double footboards and riser planks.

NEW! Extruded riser provides even more strength and easier aisle assembly!

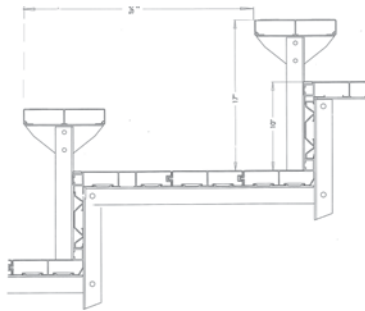

Fully Enclosed Deck

Many of the various recent codes for outdoor bleacher seating require any opening more than 30" above the ground be small enough so that a 4" sphere cannot pass through. Kay Park has designed a system using tongue and groove planks for added strength and complete enclosure. Extruded riser provides even more strength and easier aisle assembly! Call for Pricing.



Custom Bleacher Wrap

Add custom wrap to your new bleachers for the finished look or add to older bleachers to add school spirit.

- Custom Design (Logo)
- Up to 60" Wide Panels Sections
- Direct Print to Mesh
- Full Color Bleed
- Grommets for Easy Assembly
- **Call for Pricing**

BLA Series Aluminum Angle Frame

Aluminum frames fabricated from a combination of 2" x 2" x 3/16" 6061-T6 alloy aluminum angles and channel using a punched and bolted type construction for maximum strength and safety. All main frame components are pre-assembled with large 1/2" diameter bolts, lock washers and nuts. This bolted aluminum frame provides strong joints that will not develop weld cracks. Model number with a 'BLA' are aluminum frames.

BLG Series Galvanized Steel Frame

Steel frames are fabricated from A36 alloy steel angles using full welds at all joints to give added strength. A combination of 2" x 2" x 3/16" and 1 3/4" x 1 3/4" x 3/16" angles are used, as required, for strength throughout each frame. Connecting "X" braces are 1 1/2" wide by 1/4" thick A36 alloy steel. For greatest protection and longest life, all parts are hot-dip galvanized after fabrication. Model numbers with a 'BLG' are galvanized steel frames.

Aisles & Handrails

Your local code may require one or more aisles and handrails. We do custom bleachers but some typical aisles are a 48" wide center aisle with handrail or a 36" wide aisle for an end aisle. Aisles require double footboards and risers and meet 4" opening guidelines. Heavy duty non-slip step up indicator tape is placed on each step for safety. Model numbers with '48AHR' include a 48" wide center aisle with handrail. Model numbers with '36A' include a 36" end aisle. Contact a sales rep for pricing.

Wheelchair Cut Outs

Check with your local code to see if they require wheelchair cut outs. The double wheelchair space allows for two wheelchairs and a companion to sit directly beside each wheelchair. Add 'DWCS' to the model number.

Bleacher Plank Specifications

Aluminum: Seat planks 6063-T6 extruded aluminum which is clear anodized to standard 204-R1 specification. Standard 8" rise per row uses 2" x 10" seats and low rise 6" rise uses 2" x 12" seats. Walk boards are 2" x 10" 6063-T6 extruded mill finish aluminum. End caps (anodized) and hold down clips are also extruded aluminum. Powder coated colors also available. Call for Details. Model numbers with a "Row#A" row number followed by an 'A' are aluminum planks. **Backrests available**. Fully enclosed decking also available.



CALL 1-800-553-2476 FOR A CUSTOMIZED QUOTE TODAY!



Press Box

- Sliding or fixed windows - Tempered
- Air Conditioner / Heat Cut out
- Built-in Shelving
- Wood Stud Walls
- Metal Siding & Roof
- Locatable, Primed Aluminum Door
- 12' x 8' or 18' x 8' Standard Size
- Over 20 Available Colors



BleaChairs™

- Plastic-contoured seat
- Lumbar support
- Includes mounting hardware and caps
- Create a VIP seating area

Elevated Bleachers



Kay Park's Elevated Bleachers are made to the same high standards and have the same superior features as our non-elevated bleachers. They are backed by our 60 plus years of expertise in building commercial outdoor recreation products. They are safety-equipped with vertical bar guardrails (V4)(patent #404-141) and double width footboards with risers beneath the seats (F4), our elevated bleachers meet the 4" sphere guideline in recent building codes. Standard sizes are 5, 8, 10 and 15 rows and come in many different lengths, and seating capacities. Our bleacher specialist can help you determine placement of entrance stairs, wheelchair ramps, wheelchair spaces and aisles ways to best suit your space, needs and code requirement.

Call 1-800-553-2476 to get your custom quote.



Flexible Placement of:

- Entrance Stairs
- Wheelchair Ramps
- Wheelchair Spaces
- Aisles
- Other Custom Options

Standard Elevated Sizes:

5, 8, 10 & 15 Rows

Available in many different lengths, & seating capacities.

CALL 1-800-553-2476 FOR A CUSTOMIZED QUOTE TODAY!
ADA Ramps



Add ADA seating to existing Non-compliant bleachers as Featured in: Dec. '14 Athletic Business

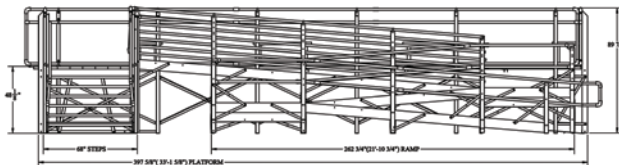

Fully Customizable

Custom ADA ramps. FREE Quotes Call Today.



Companion seats:



Standard 5, 8, 10 & 15 Rows - Many length, seating capacities & configuration!

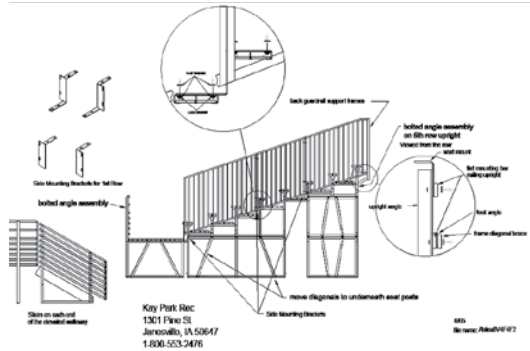
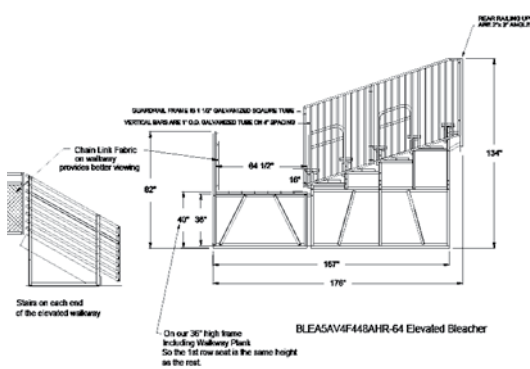

Have unique needs? We can work with you!!

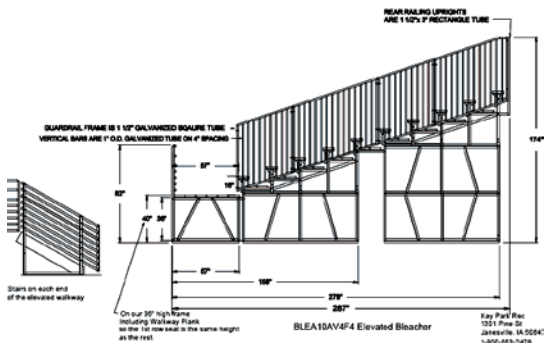

Drawings available. Call Us! 1-800-553-2476

10 Row Bleachers



10 Row Basics:
 Every 10 row includes; Safe Vertical Bar guard Rails, Double Footboards & Risers that meet the 4" Guidelines.

Local Code May Require:

- Optional ADA Spaces
- Optional Aisles

Ask about our Powder Coating Options!
 Custom color coating any or all bleacher parts.

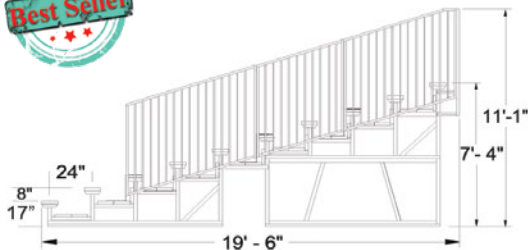

10 Row Standard 8" Rise Bleachers

Aluminum Frame

Strong 2" x 2" x 3/16" Angles & Channels

Model	Seat Plank	Rows	Length	Weight	# Seats	Price
BLA10A15V4F4	Aluminum, 2x10 seat plank	10	15'	2155 Lbs	100	\$ 8,955.00
BLA10A21V4F4	Aluminum, 2x10 seat plank	10	21'	2805 Lbs	140	\$ 11,688.00
BLA10A27V4F4	Aluminum, 2x10 seat plank	10	27'	3484 Lbs	180	\$ 15,326.00
BLA10VP15V4F4	Plastisol, 2x10 seat plank	10	15'	2962 Lbs	100	\$ 10,988.00
BLA1015V4	Frame only, incl. hardware	10	15'	1625 Lbs	100	\$ 5,410.00

Galvanized Steel Frame

1 3/4" x 1 3/4" x 2" x 2" x 3/16" Angles

Model	Seat Plank	Rows	Length	Weight	# Seats	Price
BLG10A15V4F4	Aluminum, 2x10 seat plank	10	15'	2535 Lbs	100	\$ 9,035.00
BLG10A21V4F4	Aluminum, 2x10 seat plank	10	21'	3355 Lbs	140	\$ 11,796.00
BLG10A27V4F4	Aluminum, 2x10 seat plank	10	27'	4155 Lbs	180	\$ 15,016.00
BLG10VP15V4F4	Plastisol, 2x10 seat plank	10	15'	3185 Lbs	100	\$ 11,324.00
BLG1015V4	Frame only, incl. hardware	10	15'	1614 Lbs	100	\$ 5,364.00

48AHR	48" Aisle & handrail	120 Lbs	\$ 645.00
36A	36" Aisle (15' units end only)	75 Lbs	\$ 968.00



Jiffy Mover For 10 Row

Kay Park's Jiffy Mover "crank-up" unit is fast and easy to use for just one person. Special care has gone into the Jiffy design to reduce tongue weight for easier maneuvering by hand if needed. Primarily designed for transporting 10 row, 15', 21', and 27', long bleachers. Top recommended speed is 5 MPH. Aluminum frame bleachers only.

Complete Systems - (Permanently stays w/ bleacher.)

JIF1015	10 Row, 15' long-complete system	665 Lbs	\$ 3,421.00
JIF1021	10 Row, 21' long-complete system	722 Lbs	\$ 3,560.00
JIF1027	10 Row, 27' long-complete system	777 Lbs	\$ 4,052.00





Optional ADA Wheelchair Spaces for any Bleacher.

DWCS Double Space \$135.00

8 Row Basics:

Every 8 row includes; Safe Vertical Bar guard Rails, Double Footboards & Risers that meet the 4" Guidelines.

Local Code May Require:

- Optional ADA Spaces
- Optional Aisles



8 Row Standard 8" Rise Bleachers

Aluminum Frame

Strong 2" x 2" x 3/16" Angles & Channels

Model	Seat Plank	Rows	Length	Weight	# Seats	Price
BLA8A15V4F4	Aluminum, 2x10 seat plank	8	15'	2036 Lbs	80	\$ 7,292.00
BLA8A21V4F4	Aluminum, 2x10 seat plank	8	21'	2592 Lbs	112	\$ 9,293.00
BLA8A27V4F4	Aluminum, 2x10 seat plank	8	27'	3158 Lbs	144	\$ 11,538.00
BLA8VP15V4F4	Plastisol, 2x10 seat plank	8	15'	2325 Lbs	80	\$ 8,666.00
BLA815V4	Frame only, incl. hardware	8	15'	1317 Lbs	80	\$ 4,193.00

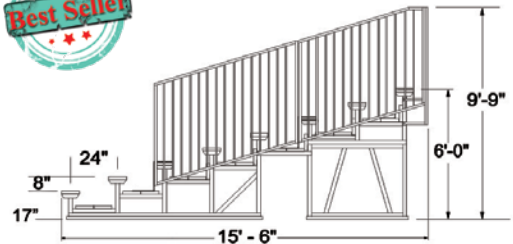

Galvanized Steel Frame

1 3/4" x 1 3/4" x 2" x 2" x 3/16" Angles

Model	Seat Plank	Rows	Length	Weight	# Seats	Price
BLG8A15V4F4	Aluminum, 2x10 seat plank	8	15'	2006 Lbs	80	\$ 7,480.00
BLG8A21V4F4	Aluminum, 2x10 seat plank	8	21'	2640 Lbs	112	\$ 9,560.00
BLG8A27V4F4	Aluminum, 2x10 seat plank	8	27'	3367 Lbs	144	\$ 11,689.00
BLG8VP15V4F4	Plastisol, 2x10 seat plank	8	15'	2601 Lbs	80	\$ 9,235.00
BLG815V4	Frame only, incl. hardware	8	15'	1271 Lbs	80	\$ 4,307.00

48AHR	48" Aisle & handrail	120 Lbs	\$ 516.00
36A	36" Aisle (15' units end only)	75 Lbs	\$ 774.00

Jiffy Mover For 8 Row

Kay Park's Jiffy Mover "crank-up" unit is fast and easy to use for just one person. Special care has gone into the Jiffy design to reduce tongue weight for easier maneuvering by hand if needed. Primarily designed for transporting 8 row, 15', 21', and 27', long bleachers.

Top recommended speed is 5 MPH. Aluminum frame bleachers only.

Complete Systems - (Permanently stays w/ bleacher.)

JIF815	8 Row, 15' long-complete system	525 Lbs	\$ 3,083.00
JIF821	8 Row, 21' long-complete system	582 Lbs	\$ 3,178.00
JIF827	8 Row, 27' long-complete system	642 Lbs	\$ 3,409.00



When Ordering Bleachers

We advise that you check your local requirements for such things as aisle, guardrails, ADA, or other requirements. Building codes may vary by year written and by group who issues them (IBC, UBC, BOCA, SBC, NFPA, etc.)

5 Row Bleachers

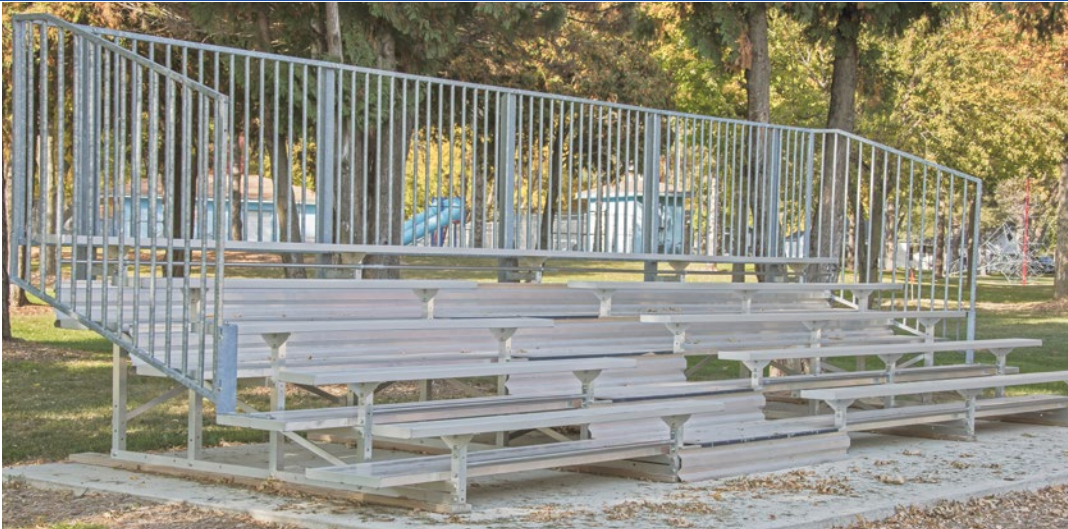

5 Row Basics:
 5 row includes Safe Vertical Bar
 Guard Rails, Double Footboards
 & Risers that meet the 4"
 Guidelines.
Local Code May Require:
 -Optional ADA Spaces
 -Optional Aisles

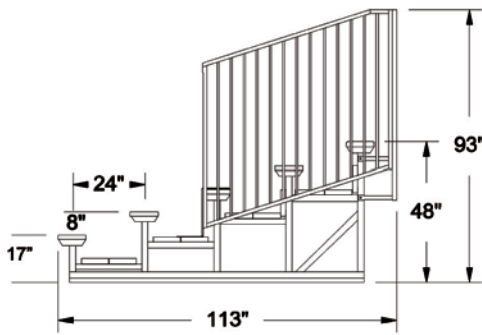

5 Row Standard 8" Rise Bleachers

Aluminum Frame

Model	Seat Plank	Rows	Length	Weight	# Seats	Price
BLA5A15V4F4	Aluminum, 2x10 seat plank	5	15'	1063 Lbs	50	\$ 3,902.00
BLA5A21V4F4	Aluminum, 2x10 seat plank	5	21'	1423 Lbs	70	\$ 5,111.00
BLA5A27V4F4	Aluminum, 2x10 seat plank	5	27'	1735 Lbs	90	\$ 6,355.00
BLA5VP15V4F4	Plastisol, 2x10 seat plank	5	15'	1255 Lbs	50	\$ 4,484.00
BLA515V4	Frame only, incl. hardware	5	15'	667 Lbs	50	\$ 2,168.00

Strong 2" x 2" x 3/16" Angles & Channels

Galvanized Steel Frame

Model	Seat Plank	Rows	Length	Weight	# Seats	Price
BLG5A15V4F4	Aluminum, 2x10 seat plank	5	15'	1124 Lbs	50	\$ 3,681.00
BLG5A21V4F4	Aluminum, 2x10 seat plank	5	21'	1494 Lbs	70	\$ 5,232.00
BLG5A27V4F4	Aluminum, 2x10 seat plank	5	27'	1863 Lbs	90	\$ 6,402.00
BLG5VP15V4F4	Plastisol, 2x10 seat plank	5	15'	1450 Lbs	50	\$ 4,708.00
BLG515V4	Frame only, incl. hardware	5	15'	718 Lbs	50	\$ 2,284.00

1 3/4" x 1 3/4" x 2" x 2" x 3/16" Angles

48AHR	48" Aisle & handrail	120 Lbs	\$ 433.00
36A	36" Aisle (15' units end only)	75 Lbs	\$ 649.00

5 Row 6" Low Rise Bleachers

Aluminum Frame

Model	Seat Plank	Rows	Length	Weight	# Seats	Price
BLRA5A15V4F4	Aluminum, 2x12 seat plank	5	15'	925 Lbs	50	\$ 3,675.00
BLRA5A21V4F4	Aluminum, 2x12 seat plank	5	21'	1273 Lbs	70	\$ 4,399.00
BLRA5A27V4F4	Aluminum, 2x12 seat plank	5	27'	1419 Lbs	90	\$ 6,076.00
BLRA515V4	Frame only, incl. hardware	5	15'	561 Lbs	50	\$ 1,916.00

Strong 2" x 2" x 3/16" Angles & Channels

Galvanized Steel Frame

Model	Seat Plank	Rows	Length	Weight	# Seats	Price
BLRG5A15V4F4	Aluminum, 2x12 seat plank	5	15'	1063 Lbs	50	\$ 3,531.00
BLRG5A21V4F4	Aluminum, 2x12 seat plank	5	21'	1456 Lbs	70	\$ 4,744.00
BLRG5A27V4F4	Aluminum, 2x12 seat plank	5	27'	1820 Lbs	90	\$ 6,025.00
BLRG515V4	Frame only, incl. hardware	5	15'	668 Lbs	50	\$ 2,027.00

1 3/4" x 1 3/4" x 2" x 2" x 3/16" Angles

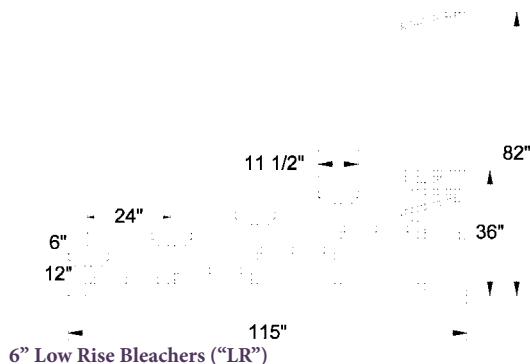

6" Low Rise Bleachers ("LR")

Aisle and handrails NOT required by many codes when: * 11 1/2 Wide seat planks

* Rise to 6" per row

* First row seat is 12" high



Jiffy Mover For 5 Row

Kay Park's Jiffy Mover "crank-up" unit is fast and easy to use for just one person. Special care has gone into the Jiffy design to reduce tongue weight for easier maneuvering by hand if needed. Primarily designed for transporting 5 row 15', 21', and 27' long bleachers. Top recommended speed is 5 MPH. Aluminum frame bleachers only.

Complete Systems	(- Permanently stays w/ bleacher.)	Weight	Price
JIF51521	5 Row, 15' & 21' long-complete system	291 Lbs	\$ 1,518.00
JIF527	5 Row, 27' long-complete system	395 Lbs	\$ 1,997.00

Component Models	5 row model only- (Transferable Parts)	Weight	Price
JIF5JACK	5 Row, jack only (1 total)	40 Lbs	\$ 224.00
JIF5WT1521	5 Row, wheel and tongue (1 total) 15', 21'	175 Lbs	\$ 559.00
JIF5WT27	5 Row, wheel and tongue (1 total) 27'	205 Lbs	\$ 641.00
JIF5FRM1521	5 Row, frame parts (1 per bleacher) 15', 21'	70 Lbs	\$ 880.00
JIF5FRM27	5 Row, frame parts (1 per bleacher) 27'	95 Lbs	\$ 954.00



5 Row Basics:

- This page has NO Guardrails
- This page has No Double Footboard & Risers

Local Code May Require:

- Optional ADA Spaces
- Optional Aisles

5 Row 8" Rise Bleachers- No Rails & 1 Footboard

Aluminum Frame

Strong 2" x 2" x 3/16" Angles & Channels

Model	Seat Plank	Rows	Length	Weight	# Seats	Price
BLA5A15	Aluminum, 2x10 seat plank	5	15'	395 Lbs	50	\$ 1,820.00
BLA5A21	Aluminum, 2x10 seat plank	5	21'	573 Lbs	70	\$ 2,412.00
BLA5A27	Aluminum, 2x10 seat plank	5	27'	708 Lbs	90	\$ 3,130.00
BLA5VP15	Plastisol, 2x10 seat plank	5	15'	587 Lbs	50	\$ 2,794.00
BLA515	Frame only, incl. hardware	5	15'	166 Lbs	50	\$ 750.00

Galvanized Steel Frame

1 3/4" x 1 3/4" x 2" x 2" x 3/16" Angles

Model	Seat Plank	Rows	Length	Weight	# Seats	Price
BLG5A15	Aluminum, 2x10 seat plank	5	15'	523 Lbs	50	\$ 1,881.00
BLG5A21	Aluminum, 2x10 seat plank	5	21'	756 Lbs	70	\$ 2,574.00
BLG5A27	Aluminum, 2x10 seat plank	5	27'	947 Lbs	90	\$ 3,257.00
BLG5VP15	Plastisol, 2x10 seat plank	5	15'	704 Lbs	50	\$ 2,899.00
BLG515	Frame only, incl. hardware	5	15'	293 Lbs	50	\$ 872.00

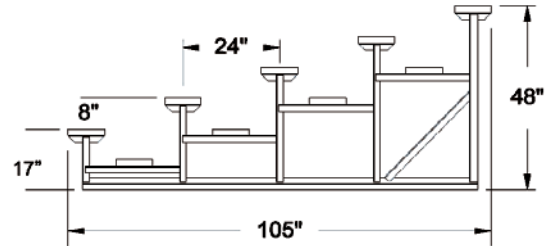

5 Row 6" Low Rise Bleachers- No Rails & 1 Footboard

Aluminum Frame

Strong 2" x 2" x 3/16" Angles & Channels

Model	Seat Plank	Rows	Length	Weight	# Seats	Price
BLRA5A15	Aluminum, 2x12 seat plank	5	15'	395 Lbs	50	\$ 1,887.00
BLRA5A21	Aluminum, 2x12 seat plank	5	21'	573 Lbs	70	\$ 2,610.00
BLRA5A27	Aluminum, 2x12 seat plank	5	27'	708 Lbs	90	\$ 3,454.00
BLRA515	Frame only, incl. hardware	5	15'	166 Lbs	50	\$ 609.00

Galvanized Steel Frame

1 3/4" x 1 3/4" x 2" x 2" x 3/16" Angles

Model	Seat Plank	Rows	Length	Weight	# Seats	Price
BLRG5A15	Aluminum, 2x12 seat plank	5	15'	533 Lbs	50	\$ 1,999.00
BLRG5A21	Aluminum, 2x12 seat plank	5	21'	756 Lbs	70	\$ 2,781.00
BLRG5A27	Aluminum, 2x12 seat plank	5	27'	947 Lbs	90	\$ 3,265.00
BLRG515	Frame only, incl. hardware	5	15'	273 Lbs	50	\$ 769.00

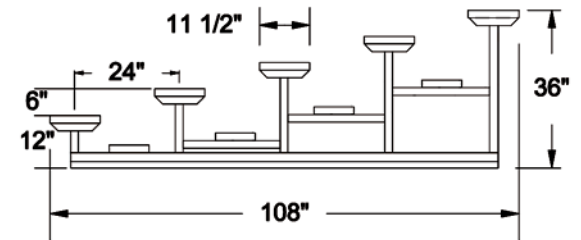

Jiffy Mover For 5 Row

Kay Park's Jiffy Mover "crank-up" unit is fast and easy to use for just one person. Special care has gone into the Jiffy design to reduce tongue weight for easier maneuvering by hand if needed. Primarily designed for transporting 5 row, 15', 21', and 27', long bleachers. Top recommended speed is 5 MPH. Aluminum frame bleachers only.

Complete Systems - (Permanently stays w/ bleacher.)

JIF51521	5 Row, 15' & 21' long-complete system	291 Lbs	\$ 1,518.00
JIF527	5 Row, 27' long-complete system	395 Lbs	\$ 1,997.00

Component Models - 5 row model only- (Transferable Parts)

JIF5JACK	5 Row, jack only (1 total)	40 Lbs	\$ 224.00
JIF5WT1521	5 Row, wheel and tongue (1 total) 15', 21'	175 Lbs	\$ 559.00
JIF5WT27	5 Row, wheel and tongue (1 total) 27'	205 Lbs	\$ 641.00
JIF5FRM1521	5 Row, frame parts (1 per bleacher) 15', 21'	70 Lbs	\$ 880.00
JIF5FRM27	5 Row, frame parts (1 per bleacher) 27'	95 Lbs	\$ 954.00



4 Row Bleachers

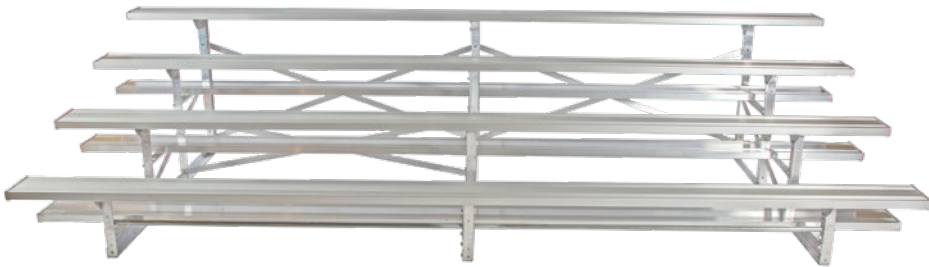

4 Row Basics:

Available with or without; Safe Vertical Bar guard Rails, Double Footboards & Risers that meet the 4" Guidelines.

Local Code May Require:

- Optional ADA Spaces
- Optional Aisles

Design Standards:

Please refer to pages 70 & 71 for design standards.

Please call 1-800-553-2476 for specification

4 Row Standard 8" Rise

Aluminum Frame

Model	Seat Plank
BLA4A15V4F4	Aluminum, 2x10 seat plank
BLA4A21V4F4	Aluminum, 2x10 seat plank
BLA4A27V4F4	Aluminum, 2x10 seat plank
BLA4VP15V4F4	Plastisol, 2x10 seat plank
BLA415V4	Frame only, incl. hardware

Strong 2" x 2" x 3/16" Angles & Channels

Rows	Length	Weight	# Seats	Price
4	15'	850 Lbs	40	\$ 3,384.00
4	21'	1138 Lbs	56	\$ 4,452.00
4	27'	1388 Lbs	72	\$ 5,543.00
4	15'	1004 Lbs	40	\$ 4,315.00
4	15'	553 Lbs	40	\$ 1,963.00

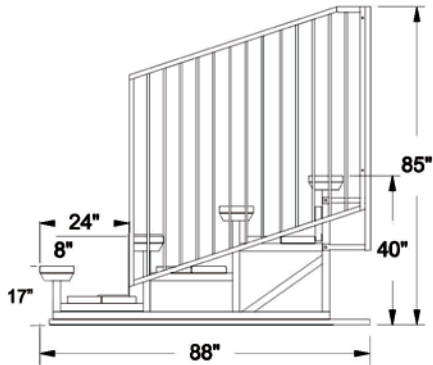

Galvanized Steel Frame

Model	Seat Plank
BLG4A15V4F4	Aluminum, 2x10 seat plank
BLG4A21V4F4	Aluminum, 2x10 seat plank
BLG4A27V4F4	Aluminum, 2x10 seat plank
BLG4VP15V4F4	Plastisol, 2x10 seat plank
BLG415V4	Frame only, incl. hardware
48AHR	48" Aisle & handrail
36A	36" Aisle (15' units end only)

1 3/4" x 1 3/4" x 2" x 2" x 3/16" Angles

Rows	Length	Weight	# Seats	Price
4	15'	930 Lbs	40	\$ 3,318.00
4	21'	1261 Lbs	56	\$ 4,342.00
4	27'	1579 Lbs	72	\$ 5,517.00
4	15'	1097 Lbs	40	\$ 4,530.00
4	15'	634 Lbs	40	\$ 1,952.00
		120 Lbs		\$ 378.00
		75 Lbs		\$ 566.00

4 Row Standard 8" Rise - No Rails & 1 Footboard

Aluminum Frame

Model	Seat Plank
BLA4A7.5	Aluminum, 2x10 seat plank
BLA4A15	Aluminum, 2x10 seat plank
BLA4A21	Aluminum, 2x10 seat plank
BLA4A27	Aluminum, 2x10 seat plank
BLA4VP15	Plastisol, 2x10 seat plank
BLA415	Frame only, incl. hardware

Strong 2" x 2" x 3/16" Angles & Channels

Rows	Length	Weight	# Seats	Price
4	7.5'	189 Lbs	20	\$ 864.00
4	15'	322 Lbs	40	\$ 1,393.00
4	21'	458 Lbs	56	\$ 1,898.00
4	27'	571 Lbs	72	\$ 2,442.00
4	15'	598 Lbs	40	\$ 2,248.00
4	15'	139 Lbs	40	\$ 584.00

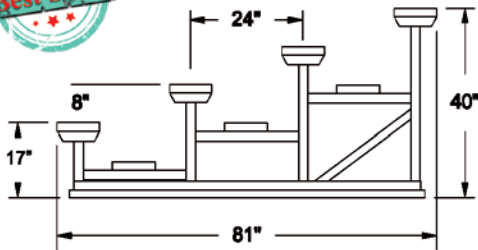

Galvanized Steel Frame

Model	Seat Plank
BLG4A7.5	Aluminum, 2x10 seat plank
BLG4A15	Aluminum, 2x10 seat plank
BLG4A21	Aluminum, 2x10 seat plank
BLG4A27	Aluminum, 2x10 seat plank
BLG4VP15	Plastisol, 2x10 seat plank
BLG415	Frame only, incl. hardware

1 3/4" x 1 3/4" x 2" x 2" x 3/16" Angles

Rows	Length	Weight	# Seats	Price
4	7.5'	240 Lbs	20	\$ 890.00
4	15'	418 Lbs	40	\$ 1,452.00
4	21'	605 Lbs	56	\$ 2,022.00
4	27'	758 Lbs	72	\$ 2,523.00
4	15'	563 Lbs	40	\$ 2,267.00
4	15'	234 Lbs	40	\$ 669.00

4 Row 6" Rise - No Rails & 1 Footboard

Aluminum Frame

Model	Seat Plank
BLRA4A7.5	Aluminum, 2x12 seat plank
BLRA4A15	Aluminum, 2x12 seat plank
BLRA4A21	Aluminum, 2x12 seat plank
BLRA4A27	Aluminum, 2x12 seat plank
BLRA415	Frame only, incl. hardware

Strong 2" x 2" x 3/16" Angles & Channels

Rows	Length	Weight	# Seats	Price
4	7.5'	198 Lbs	20	\$ 886.00
4	15'	316 Lbs	40	\$ 1,502.00
4	21'	447 Lbs	56	\$ 2,065.00
4	27'	563 Lbs	72	\$ 2,599.00
4	15'	130 Lbs	40	\$ 505.00

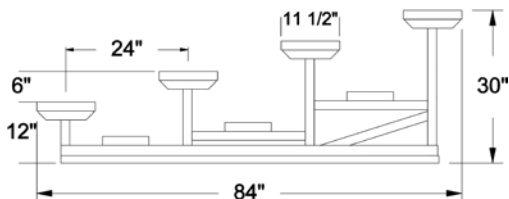
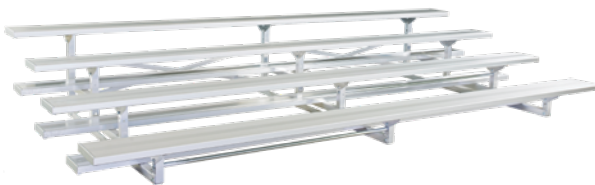

Galvanized Steel Frame

Model	Seat Plank
BLRG4A7.5	Aluminum, 2x12 seat plank
BLRG4A15	Aluminum, 2x12 seat plank
BLRG4A21	Aluminum, 2x12 seat plank
BLRG4A27	Aluminum, 2x12 seat plank
BLRG415	Frame only, incl. hardware

1 3/4" x 1 3/4" x 2" x 2" x 3/16" Angles

Rows	Length	Weight	# Seats	Price
4	7.5'	240 Lbs	20	\$ 933.00
4	15'	418 Lbs	40	\$ 1,553.00
4	21'	605 Lbs	56	\$ 2,138.00
4	27'	758 Lbs	72	\$ 2,693.00
4	15'	234 Lbs	40	\$ 582.00

4 Row Basics:

- This page has NO Guardrails
- This page has No Double Footboard & Risers

Local Code May Require:

- Optional ADA Spaces
- Optional Aisles

6" Low Rise Bleachers ("LR")

Aisle and handrails NOT required by many codes when:

- * 11 1/2 Wide seat planks
- * Rise to 6" per row
- * First row seat is 12" high

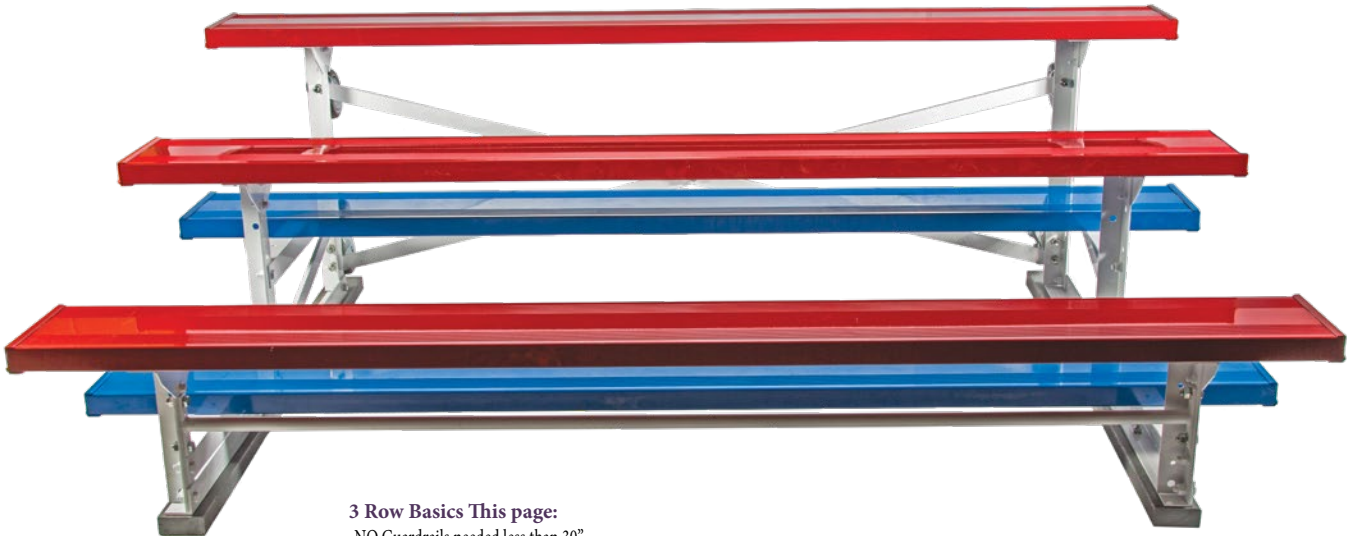

- 3 Row Basics This page:**
- NO Guardrails needed less than 30"
 - NO Double footboards
 - Check your local codes
- Local Code May Require:**
- Optional ADA Spaces
 - Optional Aisles

**Shown Tip & Roll
with custom powder coat.
Call for price quote.
1-800-553-2476**



3 Row 7" Rise Aluminum Frame

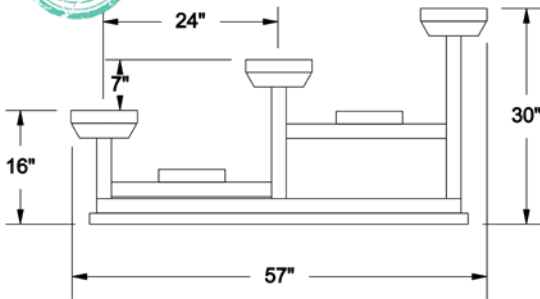

Model	Seat Plank
BLA3A7.5	Aluminum, 2x10 seat plank
BLA3A15	Aluminum, 2x10 seat plank
BLA3A21	Aluminum, 2x10 seat plank
BLA3A27	Aluminum, 2x10 seat plank
BLA3VP15	Plastisol, 2x10 seat plank
BLA315	Frame only, incl. hardware

Strong 2" x 2" x 3/16" Angles & Channels

Rows	Length	Weight	# Seats	Price
3	7.5'	136 Lbs	15	\$ 583.00
3	15'	223 Lbs	30	\$ 1,008.00
3	21'	326 Lbs	42	\$ 1,389.00
3	27'	420 Lbs	54	\$ 1,765.00
3	15'	342 Lbs	30	\$ 1,627.00
3	15'	95 Lbs	30	\$ 411.00

Galvanized Steel Frame

Model	Seat Plank
BLG3A7.5	Aluminum, 2x10 seat plank
BLG3A15	Aluminum, 2x10 seat plank
BLG3A21	Aluminum, 2x10 seat plank
BLG3A27	Aluminum, 2x10 seat plank
BLG3VP15	Plastisol, 2x10 seat plank
BLG315	Frame only, incl. hardware

1 3/4" x 1 3/4" x 2" x 2" x 3/16" Angles

Rows	Length	Weight	# Seats	Price
3	7.5'	160 Lbs	15	\$ 596.00
3	15'	277 Lbs	30	\$ 991.00
3	21'	395 Lbs	42	\$ 1,380.00
3	27'	510 Lbs	54	\$ 1,818.00
3	15'	385 Lbs	30	\$ 1,646.00
3	15'	151 Lbs	30	\$ 420.00

3 Row 6" Low Rise Aluminum Frame

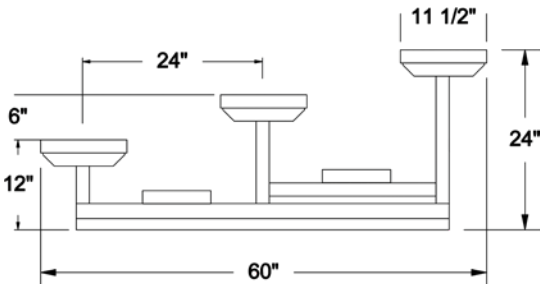

Model	Seat Plank
BLRA3A7.5	Aluminum, 2x12 seat plank
BLRA3A15	Aluminum, 2x12 seat plank
BLRA3A21	Aluminum, 2x12 seat plank
BLRA3A27	Aluminum, 2x12 seat plank
BLRA315	Frame only, incl. hardware

Strong 2" x 2" x 3/16" Angles & Channels

Rows	Length	Weight	# Seats	Price
3	7.5'	136 Lbs	15	\$ 679.00
3	15'	223 Lbs	30	\$ 1,149.00
3	21'	326 Lbs	42	\$ 1,587.00
3	27'	420 Lbs	54	\$ 2,005.00
3	15'	95 Lbs	30	\$ 492.00

Galvanized Steel Frame

Model	Seat Plank
BLRG3A7.5	Aluminum, 2x12 seat plank
BLRG3A15	Aluminum, 2x12 seat plank
BLRG3A21	Aluminum, 2x12 seat plank
BLRG3A27	Aluminum, 2x12 seat plank
BLRG315	Frame only, incl. hardware

1 3/4" x 1 3/4" x 2" x 2" x 3/16" Angles

Rows	Length	Weight	# Seats	Price
3	7.5'	160 Lbs	15	\$ 705.00
3	15'	277 Lbs	30	\$ 1,136.00
3	21'	395 Lbs	42	\$ 1,572.00
3	27'	510 Lbs	54	\$ 1,995.00
3	15'	151 Lbs	30	\$ 418.00

6" Low Rise Bleachers ("LR")

Aisle and handrails NOT required by many codes when:

- * 11 1/2 Wide seat planks
- * Rise to 6" per row
- * First row seat is 12" high

When Ordering Bleachers

We advise that you check your local requirements for such things as aisle, guardrails, ADA, or other requirements. Building codes may vary by year written and by group who issues them (IBC, UBC, BOCA, SBC, NFPA, etc.)

2 Row, Back2Back & Bleacher Renovation

2 Row 8" Rise Bleachers

Aluminum Frame

Model	Seat Plank	Rows	Length	Weight	# Seats	Price
BLA2A7.5	Aluminum, 2x10 seat plank	2	7.5'	83 Lbs	10	\$ 427.00
BLA2A15	Aluminum, 2x10 seat plank	2	15'	145 Lbs	20	\$ 728.00
BLA2A21	Aluminum, 2x10 seat plank	2	21'	225 Lbs	28	\$ 999.00
BLA2A27	Aluminum, 2x10 seat plank	2	27'	260 Lbs	36	\$ 1,284.00
BLA2A15	Frame only, incl. hardware	2	15'	77 Lbs	20	\$ 331.00

Strong 2" x 2" x 3/16" Angles & Channels

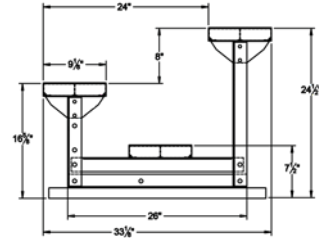

Great for Multiple Courts & Fields!

New!



3 Row 7" Rise Back 2 Back Bleachers

Aluminum Frame

Model	Seat Plank	Rows	Length	Weight	# Seats	Price
BLDA3A7.5	Aluminum, 2x10 seat plank	3	7.5'	240 Lbs	25	\$ 1,244.00
BLDA3A15	Aluminum, 2x10 seat plank	3	15'	299 Lbs	50	\$ 1,729.00
BLDA3A21	Aluminum, 2x10 seat plank	3	21'	561 Lbs	70	\$ 2,354.00
BLDA3A27	Aluminum, 2x10 seat plank	3	27'	690 Lbs	90	\$ 3,056.00
BLDA3A15	Frame only, incl. hardware	3	15'	164 Lbs	50	\$ 732.00

Strong 2" x 2" x 3/16" Angles & Channels

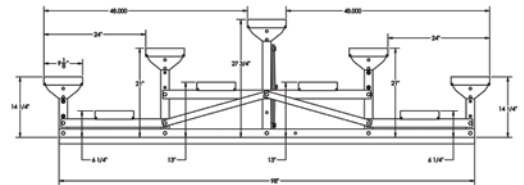

Bleacher Renovation



Tired of replacing wood planks?
Switch to Aluminum!



Before & After

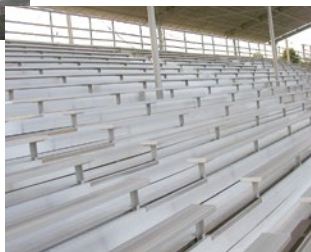

Custom ADA ramps.
FREE Quotes
Call Today.



**15-20 MINUTE
SET UP**



“Quick Seat” Bleachers - (Patent Pending)

“Quick Seat” is easy and economical way to provide temporary seating with a good visibility for everyone.

Can be set up as one long continuous bleacher by attaching end-to-end eliminating guard rails between each section.

Quick seats can be sized to accommodate just a few or large crowds (100s of people) all with minimal effort

Standard 5 row unit includes guardrail double footboards and risers. Also available in 2 and 3 row. (Guardrails NOT required)

BLQA5A15V4F4 5 Row 15' Long Complete 990 Lbs \$ **6,840.00**

- *Sports Events*
- *School Activities*
- *Multi Purpose Room*
- *Training*
- *Entertainment Shows*
- *Speakers*
- *Demonstrations*
- *Concerts*

Great For Rentals!

Minimal Storage Space

One Person can Easily Transport and Set Up

JUST 4 EASY STEPS:

1.) Set up Frame

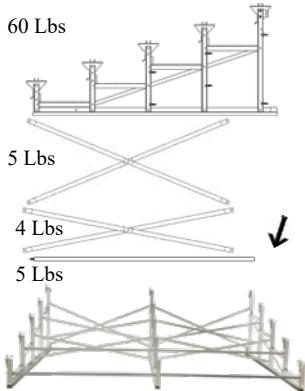

2.) Quick Latch Plank

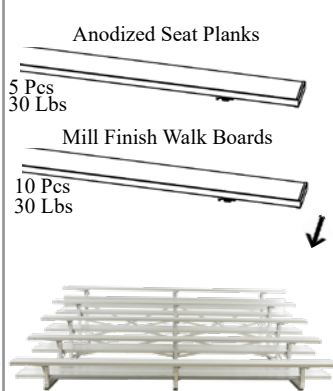

3.) Pin Railing Uprights

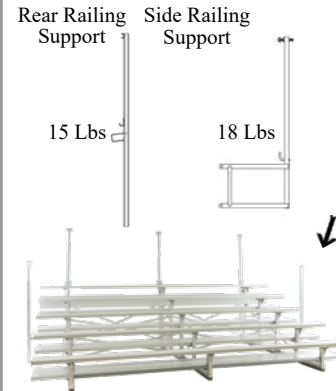

4.) Pin on Railings

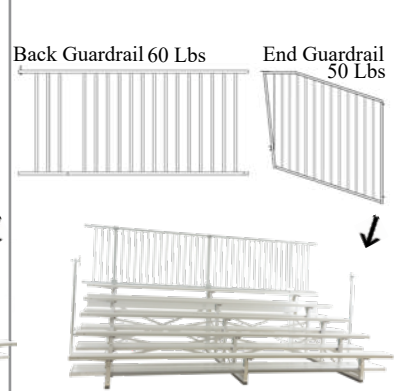

Tip & Roll System



Kay Park Tip & Roll Bleachers are particularly suitable for your indoor seating that must be moved from one activity to another. Non-marring sills prevent scuffing of floors. Their special length rear extension and clearance above the floor makes tipping either aluminum or galvanized frames in 3, 4, & 5 row models, without railing. Tipping will be easiest with aluminum frames. The set of four 5” casters set contains 2 casters with brakes. **NOT available on 8 & 10 row bleachers**

Length	Rise		3 Row	4 Row	5 Row	
15'	8"	4-5" Casters	31 Lbs	BLTR315 \$ 121.00	BLTR415 \$ 136.00	BLTR515 \$ 151.00
21'	8"	4-5" Casters	31 Lbs	BLTR321 \$ 132.00	BLTR421 \$ 153.00	BLTR521 \$ 174.00
27'	8"	6-5" Casters	44 Lbs	BLTR327 \$ 189.00	BLTR427 \$ 214.00	BLTR527 \$ 239.00
15'	6"	4-5" Casters	31 Lbs	BLTRLR315 \$ 184.00	BLTRLR415 \$ 205.00	
21'	6"	4-5" Casters	31 Lbs	BLTRLR321 \$ 216.00	BLTRLR421 \$ 228.00	
27'	6"	6-5" Casters	44 Lbs	BLTRLR327 \$ 258.00	BLTRLR427 \$ 251.00	

Put Safety First! Easy to Move Tip & Roll

Speedy Stage

Easy To Use!

1. Park It!



SPSTG27 Shown

Highway Towable Elevated Folding Stage

All-weather construction of Galvanized Steel and Aluminum

2. Unfold It!

Saves Time and Money



SPSTG27 Shown

Standard Features:

- 12 Volt Hydraulic Operating System
- Push Button Folding
- Adjustable Stabilizing Jacks
- Telescopic Tongue
- LED Lights
- Electric Brakes
- Stairs
- Stationary Safety Rails
- Aluminum Deck
- Outlets
- Tandem Axle
- Optional Spare Tire
- Laminated Plywood Deck



3. Use It!

Stretch Budget 1 unit Multiple Locations



This customer loves his Speedy Stage! He brings his show to life with the Speedy Stage decked out!

Speedy Stage

	Folded	Unfolded	Tow	Weight
SPSTG27	27'L x 8.5'W x 8.6'H	27'L x 16'W x 40"H	30'L x 8.5'W x 8.6'H	4,850 Lbs
SPSTG3020	30'L x 8.5'W x 11.6'H	30'L x 20'W x 48"H	34'L x 8.5'W x 11.6'H	8,950 Lbs

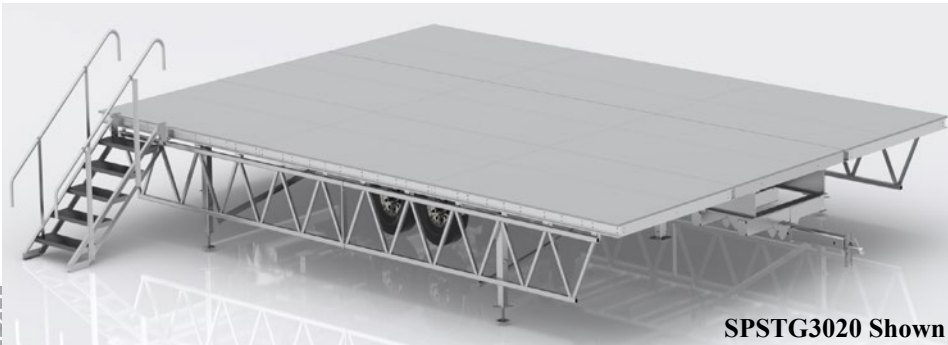

SPSTG3020 Shown

*Call for Price Quote Today!
1-800-553-2476*

Speedy Bleacher - Highway Towable Bleacher

1. Park It!



Standard Features:

- Vertical baluster bar guard rails (deters climbing) Pat. 404-141
- Hot-dip galvanized guard rail
- Heavy I-Beam main frame
- Aluminum seats & walk boards
- Stop, turn & clearance lights
- Electric brakes all four wheels
- 12-Volt hydraulic folding mechanism (self-contained battery & charger)
- Full 24" row spacing for today's taller people
- Telescoping tongue is removable (EZ slide tongue roller system)
- Semi-trailer type stabilizing jacks (high sway-load capacity 35,000 Lbs static load each)

2. Unfold It!

Easy
Push-Button
Operation!



- Lease to Own Options Available
- Share with City, School or Fair
- Rent to Generate Revenue

3. Use It!

Optional Features:

- Full width footboards & risers
- 48" Aisle (reduces capacity by 27 seats)
- Sturdy aisle handrail
- Push button operated hydraulic jacks
- Goose-neck towing hitch (folds flat)
- Storage Basket



Seating for 300 People
In less
than
10 Minutes!

Call for Price Quotes
Today!
1-800-553-2476

Speedy Bleacher - Highway Towable Bleacher

Call for Price Quotes Today!
1-800-553-2476



**Change to 3,000 Seats
In 1 hour!**

**Create A Stadium Anywhere
You Need The Seating!**



**Seating,
Where YOU need it,
When YOU need it,
FAST!**

Great for all of the following:

- Parades
- Baseball/Softball
- Football/Rugby
- Concerts
- Track/Cross Country
- Assemblies
- Graduation
- Tennis
- Soccer
- Tournaments
- Fairs/ Festivals
- Celebrations
- Speakers
- Training
- Arenas
- Golf
- Bands or on the sidelines.

Speedy Bleacher - Highway Towable Bleacher

**Best in
The
Market**



**Highway
Towable!**

Invest Thoughtfully

	Seating Capacity	Row Length	Static Jack Load Cap.	Width	Length	Tow Width	Tow Length	Tow Height	Total Weight	Tongue Weight
7 Row SPBL2707	108	27'	30,000#	13'6"	29'3"	102"	32'11"	8'11"	4,100 Lbs	Approx. 550Lbs

	Seating Capacity	Row Length	Static Jack Load Cap.	Width	Length	Tow Width	Tow Length	Tow Height	Total Weight	Tongue Weight
8 Row SPBL2708	123	27'	30,000#	15'6"	29'3"	102"	32'11"	8'11"	5154 Lbs	Approx. 700Lbs

Speedy Bleachers can be Parked, Set Up & Ready to use In just 10 Minutes

	Seating Capacity	Row Length	Static Jack Load Cap.	Width	Length	Tow Width	Tow Length	Tow Height	Total Weight	Tongue Weight
9 Row SPBL3009	180	30'	140,000#	17'4"	31'6"	102"	35'1"	10'9"	8,830 - 9,480 Lbs	Approx. 1,270 Lbs
SPBL4009	234	39'	210,000#	17'4"	41'6"	102"	45'1"	10'9"	9,400 - 11,400 Lbs	Approx 1,600 Lbs
SPBL4509	270	45'	210,000#	17'4"	46'6"	102"	50'1"	10'9"	11,690 - 12,270 Lbs	Approx. 1,750 Lbs

	Seating Capacity	Row Length	Static Jack Load Cap.	Width	Length	Tow Width	Tow Length	Tow Height	Total Weight	Tongue Weight
10 Row SPBL3010	200	30'	140,000#	19'4"	31'6"	102"	35'1"	12'6"	8,730 - 9,470 Lbs	Approx. 1,175 Lbs
SPBL4010	260	39'	210,000#	19'4"	41'6"	102"	45'1"	12'6"	9,400 - 11,900 Lbs	Approx 1,550 Lbs
SPBL4510	300	45'	210,000#	19'4"	46'6"	102"	50'1"	12'6"	12,020 - 13,170 Lbs	Approx. 1,730 Lbs

Options to fit your needs! CALL TODAY! 1-800-553-2476



Semi-Trailer type stabilizing jacks, 35,000 Lbs each. 4 jacks on 30' Speedy and 6 jacks on 40' & 45' Speedy. Operate from a standing position. Pat. No. 6,499,258



All Jacks are operated from the back side of the SPEEDY BLEACHER while you are in a full-upright standing position. (No stooping or squatting to operate numerous small jacks.) On 9 and 10 row units.



A Central Aisle & Sturdy Hand Rail are Good Safety Options. Come standard on 7 and 8 row units.



ADA wheelchair spaces! Includes required companion seats.

Pedal Boats



Special Orders
May Cost Extra.

**1,000+ Lbs
Net Flotation**

**1,500+ Lbs
Net Flotation**

PCII 2 Passenger 22.1 cu ft. Flotation

PCII Glitter	9'6" L x 5'3" W x 2'6" H	260 Lbs	\$2,496.00
PCII	9'6" L x 5'3" W x 2'6" H	260 Lbs	\$2,293.00

PCIV 4 Passenger 30.4 cu ft. Flotation

PCIV Glitter	10'4" L x 5'3" W x 2'6" H	320 Lbs	\$2,628.00
PCIV	10'4" L x 5'3" W x 2'6" H	320 Lbs	\$2,420.00

Reinforced Fiberglass
Finish in bright eye catching colors!
Std: Red, Blue Yellow, Shamrock, Green,
and Forest Green.

Steering Wheel
Is center mounted so either passenger
can operate. (Steers like a car!)
(Not confusing like a handle.)

Direct Drive Paddle Wheel
Is specially designed for greater speed
and easier pedaling!

Built-In Non Skid Surface
on PCIV rear deck!
(Not stick on strips.) Rear
deck has raised perimeter
to help prevent things
from sliding off.

Resilient Vinyl Molding
All around perimeter
helps absorb shocks!

Anodized Aluminum Grab Rails
around rear deck!
(Hand rails also available for sides.)

100% Foam-Filled pontoons
Boat floats level even if one
pontoon is punctured!
(Very important safety factor!)

**Front Marine-Grade Chromed
Handles & Stainless Mooring Eye**
on each side for convenience!
(Mooring eyes or handles in other
locations also available.)

Four Regreassable Bronze Bearings
With easy-to-reach fittings.
(Cuts downtime and lost profit!)

**Patented, Self-Draining Pedal Wells,
Seats, and Pontoons**
So water automatically drains out!



Kay Park Pedal Boats

Pedal boats by Kay Park Recreation are the best commercial-duty fiberglass pedal boats on the market. These pedal boats feature foam-filled pontoons, re-greaseable bearings, and are self-draining, making them a trouble-free pedal boat choice for rental operations in public parks, camps and resorts.



Virtually Maintenance-Free

"We've been buying Kay Park Pedal Cruisers for years. We've tried other pedal boats in the past, but we got tired of pulling them out to drain and repair them. Our Kay Park Pedal Cruisers stay in the water all season without giving us any trouble. We don't buy anything else!"

The Difference is Kay's

- Aluminum Grab Rails**
Are around rear deck! (Hand rails available for sides)
- **Marine-Grade Chromed Handles**
Are on each side for convenience!
- **Resilient Vinyl Mouldings**
Are all around the perimeter to help absorb shocks!
- **Four Regreaseable Bronze Bearings**
(This cuts downtime and lost profit!)
- **Built-in Non-skid Surface**
Are on PCIV rear deck! (NOT stick-on strips)
- Proven reliability - Safety Engineered**

Don't Forget the Life Jackets! See page 93!



100% Foam Filled
Virtually Unsinkable. Even a punctured pontoon still floats level. Big safety factor - self draining.

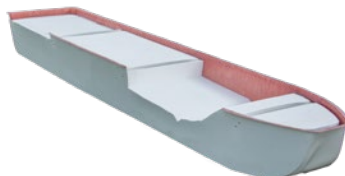

Canopy

This optional pedal boat accessory is perfect to protect riders from the hot sun. 25 Lbs.

Canopy White \$ 250.00



Direct Drive

The direct drive feature and four convenient grease fittings minimize down time and maintenance cost. Disc paddle wheel made for easier pedaling, greater thrust.



Boat Covers

Optional Marine grade boat covers are custom made to fit Kay Park Pedal Cruisers. Great to keep boats clean and prevent fading when not in use. 5 Lbs. Light Gray Color

PCIVCOVER 4 Passenger \$ 375.00
PCIICOVER 2 Passenger \$ 375.00



Easy Steering

Handy wheel location, steers in direction you turn wheel. New, more responsive rudder design.



Self Draining

Never have to drain these boats! Any water that gets in automatically drains back into the lake. No drain plugs needed.

Stainless Steel

Optional stainless steel hardware is available. Consider this option if boats will be used in salt water.

SS Stainless steel hardware \$ 250.00



SAFE, STABLE & FUN!

NuCanoe - Classic

Specs:	Classic 10	Classic 12
Length:	10'	12'
Beam (Width):	42"	42"
Height:	13-16"	12-16"
Draft:	4-6"	4-6"
Hull Weight:	59 Lbs	77 Lbs
Seating Capacity:	1 - 2 ppl	1-3 ppl
Max Weight Capacity:	450 Lbs	525 Lbs
Maximum Auxiliary Power:	2 Hp or equivalent	2 Hp or equivalent
Price:	\$ 699.00	\$ 824.00

Each Boat comes w/ 2 Plastic Bench Seats







KID AND PET FRIENDLY!

Tough Molded Plastic



Colors:

-  Orange
-  Lime
-  Cyan
-  Army Camo



VIRTUALLY UNSINKABLE

Options For Classic-"C" Frontier-"F"



Bench Seat

Bench seat for the classic NuCanoe that comes with two thumbscrews for securing into the hull of the NuCanoe. "C"

KPNC3040 Classic Bench Seat 3.5 Lbs **\$ 50.00**



360° Pinnacle Seat

360 mobility is just an added feature, the Pinnacle seat features breathable fabric XL seat bottom and adjustable lumbar. "F"

KPNC3000 360 Pinnacle Seat - No Base 9.6 Lbs **\$ 350.00**
 KPNC3001 360 Pinnacle Seat - R360 Low Base 9.6 Lbs **\$ 250.00**



Transport Dolly

The transport dolly makes it easy to transport your NuCanoe boat on land. From your roof rack, truck or trailer to the water with just the snap of button. "C" AND "F"

KPNC2610 Transport Cart 5 Lbs **\$ 120.00**



U-Joint Tiller Ext.

Tiller extension handle is great to use with a trolling motor. The hand telescopes from 32-54" for easy motor control from the center or rear seat. "C" AND "F"

KPNC7110 U-Joint Tiller Extension 3 Lbs **\$ 75.00**



Transom Motor Plate

Protect your Transom while using a motor and prevent any water from coming in through the Transom hole. Plate is made of 1/4" thick Marine starboard. "C" AND "F"

KPNC7100 Transom Motor Plate 8 oz **\$ 25.00**



One Wave Paddle

275 cm aluminum wave paddle for effortless paddling. "C" AND "F"

KPNC8070 275cm Aluminum Paddle 42 oz **\$ 85.00**

NuCanoe - Options & Life Jackets

NuCanoe - Frontier

Specs:	Frontier 10	Frontier 12
Length:	10'	12'
Beam (Width):	39"	41"
Height:	11-17"	12-17"
Draft:	3-5"	3-5"
Hull Weight:	62 Lbs	77 Lbs
Seating Capacity:	1 - 2 ppl	1-3 ppl
Max Weight Capacity:	500 Lbs	650 Lbs
Maximum Auxiliary Power:	2 Hp or equivalent	2 Hp or equivalent
Price:	\$ 1,349.00	\$ 1,599.00







Each Boat includes (1) 360 Pinnacle Seat w/ Rigid 360 Low Base



10' Frontier with Adult Livery Sport Life Jacket

Colors:

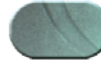
SURPRISINGLY AGILE

-  Hazard
-  Nuclear Green
-  Gulf Storm
-  Camo



Bow Motor Mount

Enable the use of a remote control. The Bow Motor Mount attaches via 3x1/4-20 screws and is made from 1" Marine Starboard. Compatible with: MinnKota Power Drive V2 Motor with MKA-21 Bracket MinnKota RipTide SP Motor with RTA-17 Bracket "P"



KPNC7150 Bow Motor Mount 1.5 Lbs \$ 100.00



Casting Bar

Easily stand and fish confidently with the Frontier Casting Bar. Includes foam grip and paddle rest. Made from powder-coated aluminum. "P"

KPNC2450 Casting Bar 7 Lbs \$ 200.00

Life Jackets: by MTI



Infant Life Jacket

- Designed for infants 0-30Lbs
- Turns baby face up in seconds
- Adjustable crotch strap and belly straps for secure fit
- Strong bright grab loop is easy to spot in water
- Design buoyancy: 9Lbs, 6oz
- USCG Type II Approved
- One Size- Infant 0-30 Lbs



KPLJINF One Size - Infant 0-30 Lbs 1 Lbs \$ 47.95



Youth Livery Life Jacket

- Lightweight and easy to put on
- Open sides and three points of closure/adj.
- Black yolk to combat sunscreen and other stains
- Design buoyancy: 11Lbs, 10oz
- USCG Type III Approved
- One Size- Youth 50-90Lbs



KPLJYTH Youth Size - Child 50-90 Lbs 1 Lbs \$ 39.95



Logo Option:

Minimum of 20 pieces
1 Color
Set-Up Fee -- \$ 25.00
Each Jacket -- \$ 3.00
Ask About Quantity Discounts.



Child Livery Life Jacket

- Lightweight and easy to put on
- Open sides and three points of closure/adj.
- Crotch strap to secure child
- Black yolk to combat sunscreen and other stains
- Design buoyancy: 7Lbs, 8oz
- USCG Type III Approved
- One Size- Child 30-50 Lbs



KPLJCHD One Size - Child 30-50 Lbs 1 Lbs \$ 37.95



Day Tripper

- Black yolk to combat sunscreen and other stains
- Three buckle front closure can be adjusted
- Black interior helps hide stains
- Perfect for schools, camps, and outfitters
- USCG Type III Approved
- Design buoyancy: 16Lbs, 13oz
- One Size Chest - 30" - 52"



KPLJDAY Universal 1 Lbs \$ 36.95



Adult Livery Sport

- Durable 300d shell is soft and mildew resistant
- Three buckle front closure can be adjusted for open front for added ventilation
- Perfect for schools, camps, and outfitters
- USCG Type III Approved
- Design buoyancy: 15Lbs, 8oz - 19lbs
- Three Sizes - XS/S - Chest - 30"-36"
M/L - Chest - 36"-44" XL/2XL - Chest - 44"-56"

KPLJALD XS/S, M/L, & XL/2XL 1 Lbs \$ 42.95



Perfect
For
Boat
Rentals

Color Options

Wood

Our standard wood in 2" x 10" and 2" x 4" is No. 1 Southern Yellow Pine. It is treated with the MCA-Micronized Copper Azole. This pressure treatment process penetrates the woods cellular structure giving it long-lasting resistance to decay and termites. Clean, odorless, non-staining and non-irritating treatment is safe and better for the environment. NAHB Green approved. Other woods are available from time to time please inquire.



Aluminum Plank

0663-T6 clear anodized to 204-R1, 2" x 10" OR 2" x 4" on benches. Anodized aluminum end caps. Bolts and aluminum clips furnished.



Recycled Plastic

Post consumer waste plastic in 2" x 10", 2" x 4", or 2" x 3" sizes. Will be reinforced with steel ribs or supplied with three legs to prevent sag. Redwood color on windsor.



Cedar Redwood Brown Gray Green

Iron Valley: pg. 59

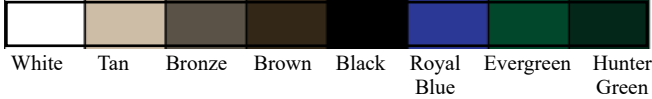

Fountain Colors: pg. 42 to 43

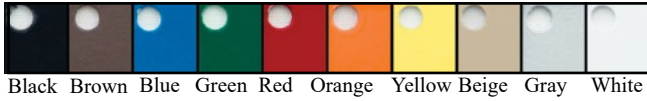

Fiberglass

Bright Ultragel colors in standard white, champagne, yellow, red, blue, stoplight blue, shamrock green, forest green or ask about **custom colors**. Built with reinforcing core type construction.

Solid Color



Granite-Look

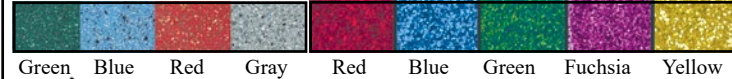

Glitter



WARNING: Cancer and Reproductive Harm www.P65Warnings.com

Garden Valance: pg. 19

Umbrella Garden Valance **UVFL7-TC** page 19.



Strap Steel: pg. 58



Concrete Options:

Concrete colors and aggregate textures.



Powder Coating Colors:

White	Yellow	Red	Burgundy	Shamrock Green
ET-1391 White FDA - 09/10126	ET-3394 RAL 1016	ET-5394 RAL 3020	PLX3270-04 RAL 3003 S/G	PLXZ2817-04 RAL 6040
Forest Green	Royal Blue	Forest Service Brown	Black	
ET-6494 RAL 6004	ET-73-40533 RAL 5002	ET-73-8691 RAL 8014	PLXZ158-80 RAL 9005	

Shade Covers: pg. 73

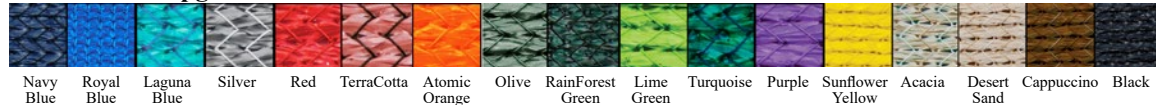

Thermoplastic Colors: pg. 56-57

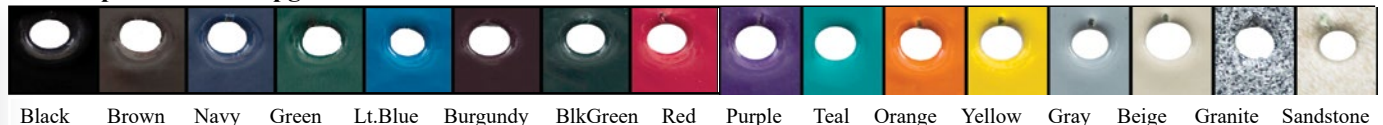

Vinylast Plastisol (PVC)

Heavy PVC coating on NO. 9 BY 3/4" expanded metal with 2" steel boarder. Plastisol is California compliant with reduced levels of pthalate. Available in assorted colors. Rectangle table tops are 30" wide and second seats are 10" wide, both have 2" vertical border. Standard lengths.



WARNING: Cancer and Reproductive Harm www.P65Warnings.com

Compare Coatings



Vinyl Plastisol Coated Expanded Metal

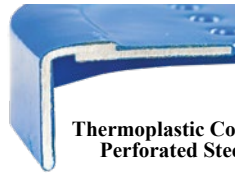

Thermoplastic Coated Perforated Steel



Thermoplastic Coated Economical Flattened Expanded Metal

Comfort	★★★★★	★★★★☆	★★★★☆
Thickness	130 mils	25-30 mils	25-30 mils
Vandal/ Graffiti Resistant	★★★★☆	★★★★★	★★★★★
Material	Vynylast Plastisol	Thermoplastic	Thermoplastic
Design	 Vinyl Plastisol Expanded Metal	 Thermoplastic Perforated Steel	 Thermoplastic Flattened Expanded Metal
Warranty	8 Year Limited Coating Warranty	5 Year Limited Coating Warranty	5 Year Limited Coating Warranty
Customer Comments	“Amazingly soft and durable! Same great “kid-friendly” coating used on the best playground equipment!”	“This glossy finish makes for easy clean up!”	“We could purchase more for our money!”



WARNING: Cancer and Reproductive Harm www.P65Warnings.com

Terms & Conditions:

Terms: Net 30 days from date of invoice to those with approved credit. A 1½% per month finance charge will be applied to payments not made within 60 days from invoice date. Current prices apply at time of shipment. We reserve the right to change specifications and prices without notice. Kay Park Recreation also accepts Visa, MasterCard, and Discover credit cards. Please note that on credit card orders, the credit card will be charged at the time of shipment.

Prices: All prices F.O.B. Factory and most products are shipped knocked down (they will require some assembly), unless quoted otherwise. While we make every effort to keep cost under control, at times market forces beyond our control can result in pricing changes. Therefore we must reserve the right to change pricing without notice.

Cancellations: Due to the possibility that expenses associated with an order may have already been incurred Kay Park Recreation must approve all cancellations of orders. Cancellation fees may apply.

Returns: Returns can be made only with the consent of Kay Park Recreation. Return fees and freight charges may apply.

Freight Charges: Are determined by the carrier. Kay Park Recreation can prepay and add to invoice. Most items are shipped knocked down to reduce freight costs. Typically some assembly may be required. Please see “Delivery” statement below.

Shipments: Made the way considered the most economical and practical unless specified routing instructions are given on the order, in which case we will do our best to follow routing guides. Shipments are also governed by ICC Regulations.

Delay in Transit: Kay Park Recreation is not responsible for delays in transit and such delays do not alter our invoicing terms. If your order does not reach you within a reasonable time after being advised the order has shipped, Kay Park Recreation will track the shipment immediately upon request.

Loss or Damage in Transit: Kay Park Recreation is released of all responsibility for loss or damage in transit by the bill of lading, which is our receipt from the carrier that the shipment was complete and in good condition. This bill of lading is forwarded to you at the time of shipment and should be checked carefully with the shipment when received by the consignee. Any shortage or damage must be noted and signed for by the delivering carrier.

Delivery: Items shipped by common carrier will be delivered curbside at the address specified on the order. The carrier is not responsible for unloading. Your location must be accessible to a large freight truck. Residential delivery, lift gate service, and call-ahead delivery are available at an additional charge and must be specified at the time of the order.

Specifications: Kay Park Recreation has a policy of continuous improvement and reserves the right to discontinue or change specifications without notice.

Weights: All weights are approximate.

Our Guarantee:

Kay Park guarantees all materials and workmanship (except labor and transportation) for one year, excluding vandalism, misuse, and acts of God. Claim for defects must be filed within one year, accompanied by copy of original invoice or invoice number.

Quick Ship Symbol

Look for this symbol to indicate Quick Ship items. Quick Ship items will ship in 10 business days from receipt of order. For quantities above 4 call for lead-time.



2 Day Shipping

Look for this symbol to indicate 2 day shipping items. For quantities up to approximately 4 only. Inquire about larger quantities.

Customer ID

Promo ID



Please forward to the proper department if this catalog has reached you in error.



Kay Park Recreation
1301 Pine Street Janesville, IA 50647
1-800-553-2476 ♦ 1-877 (KAY - PARK) ♦ 1-319-987-2900 (Fax)
529 - 7275